

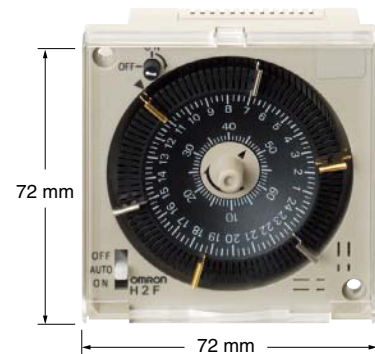

Motor Time Switch H2F-D

ON/OFF Control 48 Times per Day in 15-min Increments

The H2F-D is a Low-cost Time Switch for Affordable Operation in a Compact DIN 72 x 72-mm Body. Choose the Ideal Model to Match the Application.

- Just insert the trippers for easy setup.
- Make exact time settings using the dial.
- Three mounting methods.
- Lineup includes models with power interruption backup.
- Safety standards: UL and CSA (except for H2F-30/-31).



 The H2F-DM, -DMC, -DMF, -DMFC, -30, and -31 use nickel metal hydride batteries. Dispose of the batteries at a battery recycling location.

Ordering Information

Control cycle	Drive method	Power interruption backup	Power supply voltage	Mounting method	Flush mounting		Surface mounting/ track mounting	
					Control output	SPST-NO	SPDT	SPST-NO
Daily (24 hours)	Synchronous motor	No	100/110/120 VAC	Model	H2F-D	H2F-DC	H2F-DF	H2F-DFC
			200/220/240 VAC		H2F-D	H2F-DC	H2F-DF	H2F-DFC
	Quartz motor (See note.)	Yes	100 to 240 VAC		H2F-DM	H2F-DMC	H2F-DMF	H2F-DMFC
			12 to 24 VDC		H2F-30	---	---	H2F-31

Note: Always use the Time Switch with the Y92S-42 Battery mounted.

Accessories (Order Separately)

Name	Model
Trippers (1 set for ON and OFF) (See note 1.)	Y92S-21
Battery (See note 2.)	Y92S-42

- Note:**
1. Three gold-colored trippers for ON and three silver-colored trippers for OFF are enclosed with the H2F-D. Separately order trippers if more are required.
 2. The battery is built into the H2F-D. When the battery is nearing the end of its service life, order the model number listed at the left.

Specifications

■ Time Specifications

Type	Cycle	Minimum scale graduation	Minimum set time	Maximum set time
Daily	24 h	15 min	15 min	23 h 45 min

■ Ratings

Power supply voltage	Synchronous motor: 100/110/120 VAC, 50/60 Hz; 200/220/240 VAC, 50/60 Hz (See note 1.) Quartz motor: 100 to 240 VAC, 50/60 Hz; 12 to 24 VDC
Operating voltage range	85% to 110% of rated supply voltage
Power consumption (See note 2.)	Synchronous motor: 3 VA max. Quartz motor: 1 VA max. at 100 to 120 VAC, 4 VA max. at 200 to 240 VAC, 1 W max. at 12 to 24 VDC
Control output	15 A at 250 VAC, resistive load
Ambient operating temperature	-10 to 55°C (with no icing)
Ambient operating humidity	35% to 85%

- Note:** 1. Use the switch on the back of the H2F-D to change the frequency.
2. Inrush current will briefly flow when the power supply is turned ON.

■ Characteristics

Item	Type	Daily	
		Synchronous motor	Quartz motor
Operating time deviation (See note 1.)		±3 min max.	
Voltage influence and temperature influence			
Setting error (See note 2.)		±3 min max.	
Cyclic error		±3 min max.	
Power interruption backup time		---	180 h min. (See note 3.)
Insulation resistance		100 MΩ min. (at 500 VDC)	
Dielectric strength		2,000 VAC, 50/60 Hz for 1 min (between current-carrying metal parts and non-current-carrying metal parts and between control output and operating circuit) 1,000 VAC, 50/60 Hz for 1 min (between non-continuous contacts)	
Vibration resistance	Destruction	16.7 Hz with 2-mm single amplitude for 1 hour each in three directions	
	Malfunction	10 to 55 Hz with 0.25-mm single amplitude for 10 minutes each in three directions	
Shock resistance	Destruction	1,000 m/s ² 5 times each in 6 directions	
	Malfunction	200 m/s ² once each in 6 directions	
Life expectancy		Contacts: 10,000 operations min., Motor: 20,000 h	
Weight		Flush-mounting model: Approx. 150 g, Surface-mounting model: Approx. 200 g	
Case color		Light gray (Munsell 5Y7/1)	

- Note:** 1. Deviation in the ON time or OFF time.
2. Time difference between the set time and time required to start operation when the pointer is set to the present time.
3. Value when power has been supplied for at least 72 h at initial use.

Mounting Method

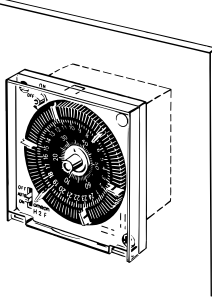
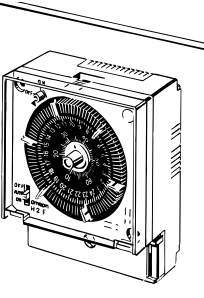
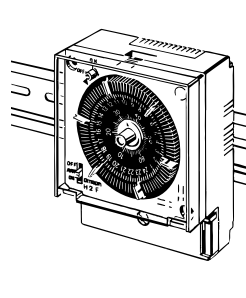
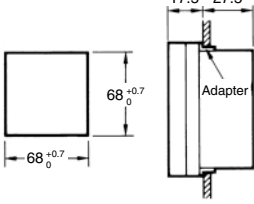
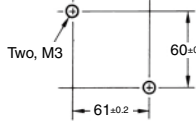
Flush Mounting	Surface Mounting	DIN Track Mounting
		
<p>72 × 72 × 45 mm (H × W × D) (below faceplate: 29 mm)</p>	<p>95 × 72 × 50 mm (H × W × D)</p>	
<p>Panel Cutout Dimensions (according to DIN 43700)</p>	<p>Mounting Screw Dimensions</p>	
 <p>Panel thickness: 1 to 3.2 mm</p>	 <p>Screw size: M3 × 45 (enclosed)</p>	
<p>Note: The mounting adapter and mounting screws are enclosed.</p>		

Removing the H2F-D from the DIN Track

Use a flat-blade screwdriver to pull down the yellow lever at the back of the bottom and remove the Time Switch.

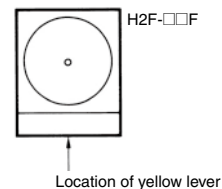

Connections

Synchronous Motor Models: SPST-NO Output

H2F-D

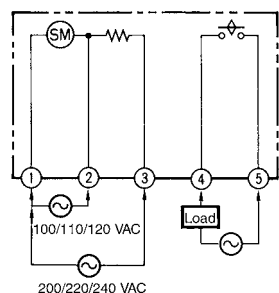

H2F-DF

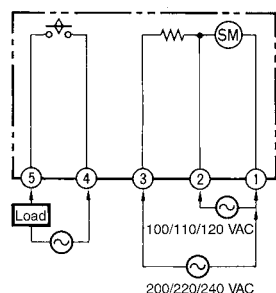

Synchronous Motor Models: SPDT Output

H2F-DC

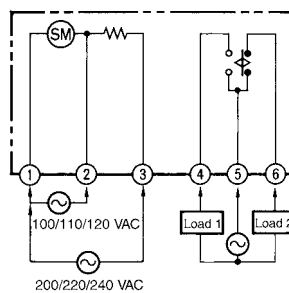

H2F-DFC

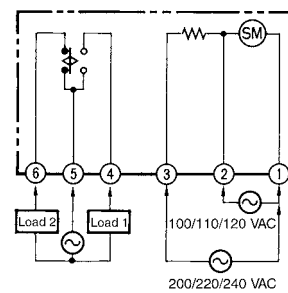

Note: 100-V-class models differ from 200-V-class models. They cannot be used together.

Quartz Motor Models: SPST-NO Output

H2F-DM, H2F-30

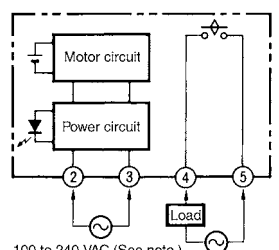

H2F-DMF

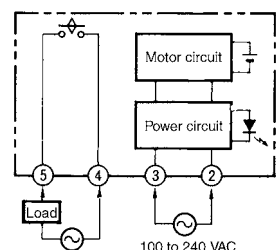

Quartz Motor Models: SPDT Output

H2F-DMC

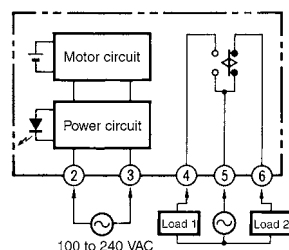

H2F-DMFC, H2F-31

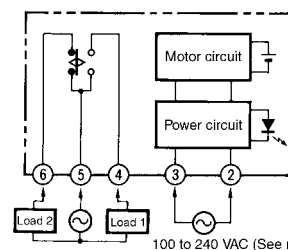

100 to 240 VAC (See note.)
 Note: On the H2F-30 (12 to 24 VDC), terminal number 2 is positive and terminal number 3 is negative.

Note: On the H2F-31 (12 to 24 VDC), terminal number 2 is positive and terminal number 3 is negative.

- Note:
1. Use a separate power supply for the load.
 2. Screw tightening torque:
Maximum torque: 0.98 N·m
 3. Use the same type of lead wires when connecting lead wires to the terminal block. If different wire types are used, it will not be possible to tighten the thin lead wires, and the wires may become disconnected during use.
 4. Recommended wire: AWG 18 to 24 (cross-sectional area: 0.205 to 0.823 mm²), solid wire or twisted wire.
 5. Do not connect more than two crimp terminals to the same terminal.

Nomenclature

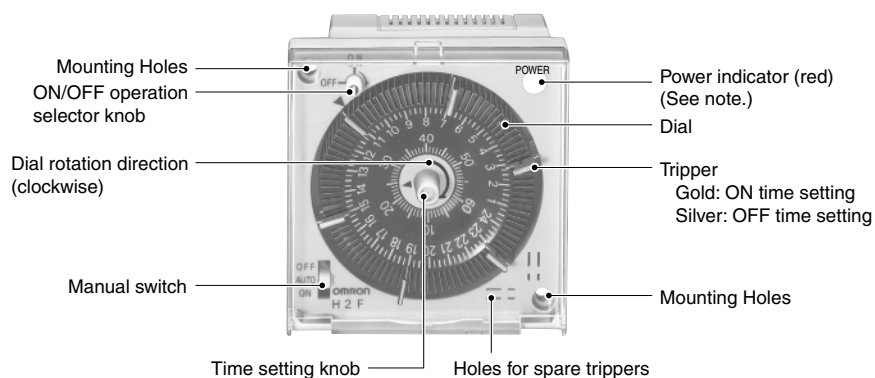

Note: Only quartz motor models have a power indicator.

Time Setting

Insert the trippers into the scale graduation at the desired times.

- Insert gold trippers for times the load is to be turned ON and silver trippers for times the load is to be turned OFF.

- Note:
1. Be sure to insert the trippers all the way.
 2. Set the trippers in alternating positions only after thoroughly checking the ON and OFF positions.

Dimensions

Note: All units are in millimeters unless otherwise indicated.

H2F-D (C)
H2F-DM (C)
H2F-30

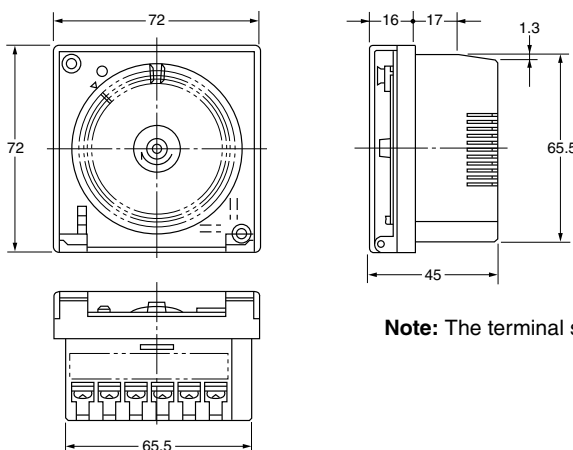
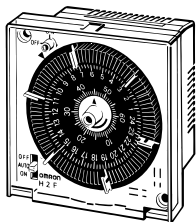

Note: The terminal screws are M3.5.

H2F-DF (C)
H2F-DMF (C)
H2F-31

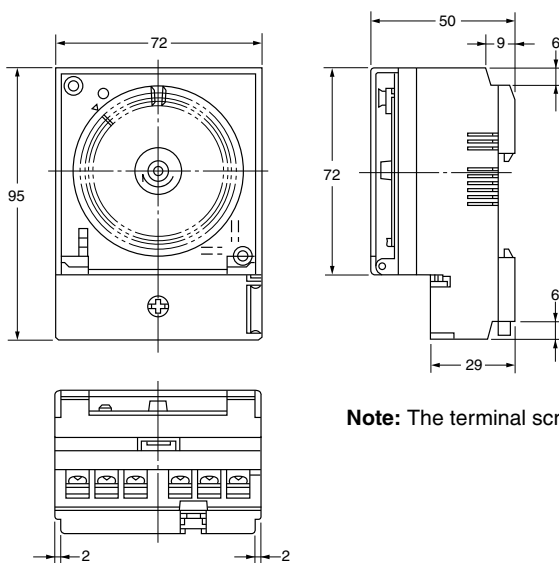
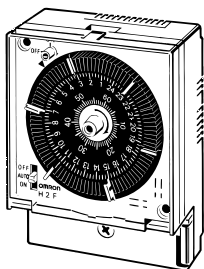

Note: The terminal screws are M3.5.

Safety Precautions

Refer to *Safety Precautions for All Timers*.

WARNING

Minor injury may occasionally occur due to the battery bursting, igniting, or leaking. Never short-circuit the positive and negative terminals, disassemble the battery, deform it under pressure, or dispose of it in fire.



CAUTION

Minor injury by electric shock may occasionally occur. Do not touch any of the terminals while power is being supplied. Be sure to mount the terminal cover after wiring.



Unexpected operation may occasionally occur.

Before changing times or other settings while power is being supplied, either turn OFF the power on the load side or set the output ON/OFF switch to OFF and confirm the safety of the system.



Fire may occasionally occur. Tighten the terminal screws to the rated torque.



Minor electric shock, fire, or product failure may occasionally occur. Do not allow metal fragments, copper wire scraps, or shavings from installation work to fall inside the Time Switch.



Minor electric shock, fire or product failure may occasionally occur. Never attempt to disassemble, modify, or repair the product or touch any of the internal parts.



Minor injury due to explosion may occasionally occur. Do not use the product where it is subject to flammable or explosive gas.



Precautions for Correct Use

Mounting

Panel Flush Mounting

- As illustrated at the right, bend the enclosed adapter in the direction of A, and then push part B in the direction of the arrow (i.e., toward the back of the panel cut).

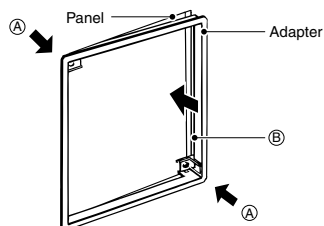

- Once the adapter has been mounted, insert the Time Switch as illustrated at the right. Secure the Time Switch in two places using the enclosed screws (M3 × 16) tightened with a torque of 0.58 N·m max.

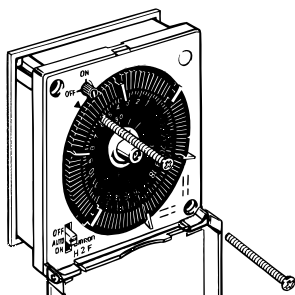

- If the lead wire has been installed in front of the panel, place the Time Switch on part A of the adapter and push it in toward B. Then secure the Time Switch by tightening the screws as described in step 2.

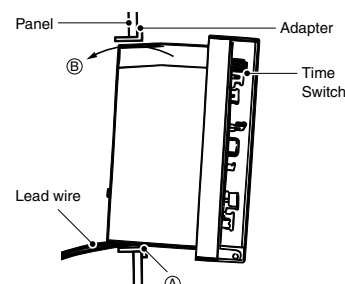

Setting the Time

- Turn the center knob clockwise to set the time. Product failure may occur if the knob is turned counterclockwise or the knob is turned while the triggers are being pressed.
- Set the hour to the arrow at the upper left and set minutes to the arrow on the center knob.
- The gold-colored triggers are for ON and the silver-colored triggers are for OFF. Securely push in the triggers with the wider part facing the outer part of the dial.
- Insert the spare triggers into the holes at the lower right for storage.

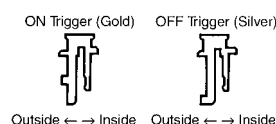
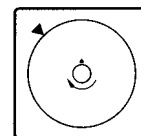

Manual Switch

Models with SPST-NO Output

The output will turn OFF regardless of trigger settings when the manual switch at the lower left of the front panel is set to OFF. The output will turn ON regardless of trigger settings when the manual switch is set to ON.

The output will turn ON and OFF according to the trigger settings when the manual switch is set to AUTO.

Models with SPDT Output

- Load 1 (terminals 4 and 5) and load 2 (terminals 5 and 6) will both turn OFF when the manual switch at the lower left of the front panel is set to OFF.

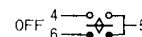

- The output will turn ON and OFF according to the trigger settings when the manual switch is set to AUTO. Load 1 (terminals 4 and 5) will turn ON and load 2 (terminals 5 and 6) will turn OFF when the manual switch is set to ON.

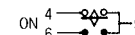

- Check the output indicator when returning operation to AUTO. If the knob has been touched or the output indicator has changed because of vibration or shock, turn the knob, switch the output, and then return operation to AUTO.

Output Indicator and ON/OFF Switch Knob

- The output indicator at the upper left of the front panel shows the output status when the manual switch is set to AUTO.

The output can also be manually switch ON or OFF by turning the knob clockwise (i.e., in the direction of the arrow). (This is possible only when the manual switch is set to AUTO.)

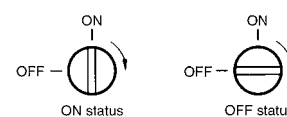

- Do not turn the ON/OFF switch knob when the manual switch is set to ON or OFF. Do not turn the Knob counterclockwise.

H2F-D/-DF Series: Synchronous Motor Models

Before mounting the Time Switch, set the frequency switch to the frequency for the region where the Time Switch will be used.

(East Japan: 50 Hz, West Japan: 60 Hz)

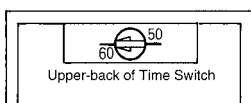

H2F-DM Series and H2F-30/-31: Quartz Motor Models

- Remove the battery cover on the back of the Time Switch. Be sure to insert the battery before supplying power. Operating the Time Switch without the battery mounted will increase the time error. Always mount the battery.

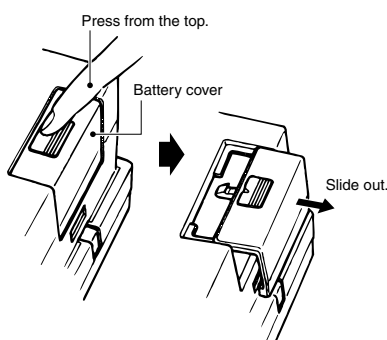

- Pay careful attention to the polarity when inserting the battery. Insert the battery following the polarity marked in the battery box of the Time Switch. Before using the Time Switch, be sure to close the battery cover after the battery is inserted.

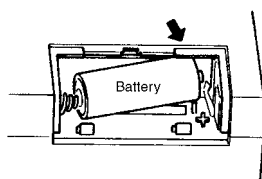

- The enclosed battery is fully charged. In the rare event that battery performance decreases due to natural discharging, the 180-hour power interruption backup function will back up operation if power has been continuously supplied for 72 hours after installing the battery in the Time Switch. If the battery is completely discharged, the Time Switch may not operate when the battery is installed. If the Time Switch does not operate, supply power for at least 3 min, and then set the time.
- Turning the power supply ON and OFF will extremely shorten the service life of the battery. Use the Time Switch with the power supplied continuously.
- The service life of the battery is approximately three years (at room temperature). If the battery has been used for three years or more, replace it as soon as possible. Using the battery close to the end of its service life will increase the time error.
- The battery may leak or cause corrosion due to excessive discharge if the H2F is left unused for an extended period with the battery mounted. Be sure to remove the battery before storing the H2F.
- Turn OFF the power supply before replacing the battery.
- Use only the specified battery (Y92S-42). The battery may leak or burst if any other battery is used, possibly resulting in equipment damage or injury.

Other Precautions

- Always use a thermo-switch on the load circuit when a heater is used.
- Operate the Time Switch within the specified rating ranges for vibration and shock.
- The H2F is not waterproof or oil resistant. Do not use the H2F in locations subject to water splashing or oil contact.

ALL DIMENSIONS SHOWN ARE IN MILLIMETERS.

To convert millimeters into inches, multiply by 0.03937. To convert grams into ounces, multiply by 0.03527.

In the interest of product improvement, specifications are subject to change without notice.

Safety Precautions for All Timers

Refer to the *Safety Precautions* for individual Timers for precautions specific to each Timer.

WARNING

The following Timers contain lithium batteries that are not explosion proof.



1. Timers with Built-in Batteries: H5L
The Timer contains a lithium battery, which may occasionally ignite or rupture. Do not disassemble, deform under pressure, heat to 100°C or higher, or incinerate the Timer.
2. Timers with Replaceable Batteries: Y92S-20 (for H5CN-M)
The battery may occasionally rupture, ignite, or leak fluid. Do not short the positive and negative terminals. Do not charge, disassemble, deform under pressure, or throw the battery into a fire. If a non-specified battery is used, the battery may leak fluid or rupture, occasionally resulting in equipment failure or minor injury. Use only the specified battery.

CAUTION

The following Timers contain lithium batteries that are explosion proof.



Timers with Built-in Batteries: H5BR, H5AN-4DM, H5S, H5F, and H4KV

The Timer contains a lithium battery, which may occasionally ignite or rupture. Do not disassemble, deform under pressure, heat to 100°C or higher, or incinerate the Timer.

Precautions for Safe Use

Operating Environment

- Use the Timer within the ratings specified for ambient operating temperature and ambient operating humidity for each model.
- Store the Timer with the specified temperature range for each model. If the Timer has been stored at a temperature of less than -10°C, allow the Timer to stand at room temperature for at least 3 hours before using it.
- Use the Timer within the performance specified for water and oil exposure for each model.
- Do not use the Timer in locations subject to shock and vibration. Long-term usage in such locations may damage the Timer due to stress.
Magnetic contactors generate a shock of 1,000 to 2,000 m/s² when switching a load. When mounting to DIN Track, separate magnetic contactors from the Timer so that the Timer is not subjected to vibration and shock. Use anti-vibration rubber.
- Do not use the Timer in locations subject to excessive dust, corrosive gases, or direct sunlight.
- Do not use organic solvents (such as paint thinner or benzene), strong alkalis, or strong acids because they will damage the external finish of the Timer.
- Separate the input devices, input wiring, and Timer as far as possible from sources of noise and power lines carrying noise.
- When using the Timer in environments subject to large amounts of static electricity (e.g., pipes carrying molding materials, powders, or fluid materials), separate the Timer as far as possible from the sources of static electricity.
- Do not remove the external case from the Timer.
- Do not use the Timer in locations where condensation may occur due to high humidity or sudden temperature changes. Condensation inside the Timer may result in malfunction or damage to Timer elements.
- The life of internal parts may be reduced if Timers are mounted in close proximity to each other.
- Resin and rubber parts (e.g., rubber packing) may deteriorate, shrink, or harden depending on the operating environment (e.g., subjected to corrosive gases, ultraviolet light, or high temperatures). We recommend periodic inspection and replacement.

- Normal operation may not be possible in locations subject to sulfidizing gas, such as in sewer systems or waste incinerators. OMRON does not market any Timers or other control devices for operation in atmospheres containing sulfidizing gas. Seal the Timer so that sulfidizing gas will not enter it. If sealing is not possible, OMRON does provide special Timers with improved resistance to sulfidizing gas. Ask your OMRON representative for details.

Power Supply

- Be sure that the voltage applied is within the specified range, otherwise the internal elements of the Timer may be damaged.
- Install a switch or circuit breaker that allows the operator to immediately turn OFF the power, and label it to clearly indicate its function.
- Maintain voltage fluctuations in the power supply within the specified range.

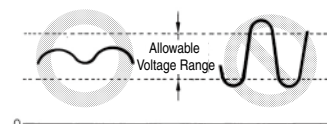

- Use a commercial power supply for the power supply voltage input to models with AC inputs. Inverters with an output frequency of 50/60 Hz are available, but the rise in the internal temperature of the Timer may result in ignition or burning. Do not use an inverter output for the power supply of the Timer.
- The Timers listed below cannot be directly turned ON and OFF by using an AC 2-wire proximity sensor to turn the Timer's power supply ON and OFF. Use the following countermeasure when using an AC 2-wire proximity sensor with the Timer. (The power supply circuit in the Timer uses half-wave rectification. Only a half AC wave is supplied to the proximity sensor, which may cause operation to be unstable.)

Applicable Models

H3Y, H3YN, H3RN, H3CA-8, RD2P, and H3CR(-A, -A8, -AP, -F, and -G)

Countermeasure

- Wire through a relay and use the relay contacts to turn the power supply ON and OFF. Confirm the stability of operation after making the connections.
- Install protective measures (such as earth leakage breakers, wiring breakers, or fuses) on the power supply side according to any applicable laws or regulations.

Correctly Handling Input Signals

Malfunction due to noise may occur if input wiring is placed in the same duct or conduit as power lines or high-voltage lines. Separate input wiring from power lines and wire them in a separate system. Also, use shielded cables, use metal conduits, and keep wiring distances as short as possible.

Timers with Relays

- Do not connect a load that exceeds contact ratings, such as the switching capacity (contact voltage or contact current). Insulation faults, contact welding, contact faults, and other failures to achieve specified performance may occur and the relay may be damaged or may burn.
- Continued use with deteriorated performance may ultimately result in insulation breakdown between circuits or relay burning. The life of the built-in relay is greatly affected by switching conditions. Before using the Timer, test operation under actual application conditions and confirm that the switching frequency presents no problems in performance.
- Electrical life depends on the type of load, switching frequency, and ambient environment. Observe the following precautions when using the Timer. When switching a DC load, contact transfer may cause the contacts to stick or may cause contact failure. Confirm applicability and consider using a surge absorbing element. When switching at high frequencies, heat generated by arcing may cause contacts to melt or may cause metal corrosion. Consider connecting an arc absorbing element, reducing the switching frequency, or lowering the humidity.
- The surge current depends on the type of load, which also affects contact switching frequency and the number of operations. Check the rated current and the surge current, and design the circuits with sufficient margin.

Resistive load	Solenoid load	Motor load	Incandescent lamp load
Rated current	10 to 20 times the rated current	5 to 10 times the rated current	10 to 20 times the rated current

Sodium light loads	Capacitor loads	Transformer loads	Mercury light loads
1 to 3 times the rated load	20 to 40 times the rated load	5 to 15 times the rated load	1 to 3 times the rated load

- Arcing when switching and relay heating may result in ignition or explosion. Do not use the Timer in atmospheres subject to inflammable or explosive gases.
- Contact faults may occur. Do not use the Timer in atmospheres subject to sulfidizing gas, chloride gas, or silicon gas.
- The switching capacity for DC voltage loads is lower than that for AC voltage loads.

Timers with Non-contact Outputs

- Short faults or open faults may occur due to destruction of the output element. Do not use the Timer for a load that exceeds the rated output current.
- Short faults or open faults may occur due to destruction of the output element from reverse electromotive force. When using the Timer for a DC inductive load, always connect a diode as a countermeasure against reverse electromotive force.

Other Precautions

- Confirm that you have the correct model before using it.
- Be sure that all terminals are wired correctly.
- Always test the output status with a tester before using a Timer with a built-in keep relay (e.g., the H3CR-H and H3DE-H). Shock resulting from dropping the Timer during transport or handling may cause the output contacts to reverse or to be in a neutral status.
- Leaving the Timer with outputs ON at a high temperature for a long time may hasten the degradation of internal parts (such as electrolytic capacitors). Use the Timer in combination with relays and avoid leaving the Timer with the output turned ON for an extended period of time (e.g., for more than a month). Reference Example (Use the Timer as shown below.)

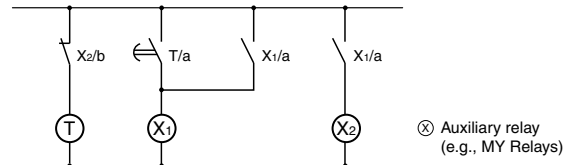

- Be sure that only a qualified worker (e.g., an electrical engineer) performs electrical work for the Timer.

ALL DIMENSIONS SHOWN ARE IN MILLIMETERS.

To convert millimeters into inches, multiply by 0.03937. To convert grams into ounces, multiply by 0.03527.

In the interest of product improvement, specifications are subject to change without notice.

Read and Understand This Catalog

Please read and understand this catalog before purchasing the products. Please consult your OMRON representative if you have any questions or comments.

Warranty and Limitations of Liability

WARRANTY

OMRON's exclusive warranty is that the products are free from defects in materials and workmanship for a period of one year (or other period if specified) from date of sale by OMRON.

OMRON MAKES NO WARRANTY OR REPRESENTATION, EXPRESS OR IMPLIED, REGARDING NON-INFRINGEMENT, MERCHANTABILITY, OR FITNESS FOR PARTICULAR PURPOSE OF THE PRODUCTS. ANY BUYER OR USER ACKNOWLEDGES THAT THE BUYER OR USER ALONE HAS DETERMINED THAT THE PRODUCTS WILL SUITABLY MEET THE REQUIREMENTS OF THEIR INTENDED USE. OMRON DISCLAIMS ALL OTHER WARRANTIES, EXPRESS OR IMPLIED.

LIMITATIONS OF LIABILITY

OMRON SHALL NOT BE RESPONSIBLE FOR SPECIAL, INDIRECT, OR CONSEQUENTIAL DAMAGES, LOSS OF PROFITS, OR COMMERCIAL LOSS IN ANY WAY CONNECTED WITH THE PRODUCTS, WHETHER SUCH CLAIM IS BASED ON CONTRACT, WARRANTY, NEGLIGENCE, OR STRICT LIABILITY.

In no event shall responsibility of OMRON for any act exceed the individual price of the product on which liability is asserted.

IN NO EVENT SHALL OMRON BE RESPONSIBLE FOR WARRANTY, REPAIR, OR OTHER CLAIMS REGARDING THE PRODUCTS UNLESS OMRON'S ANALYSIS CONFIRMS THAT THE PRODUCTS WERE PROPERLY HANDLED, STORED, INSTALLED, AND MAINTAINED AND NOT SUBJECT TO CONTAMINATION, ABUSE, MISUSE, OR INAPPROPRIATE MODIFICATION OR REPAIR.

Application Considerations

SUITABILITY FOR USE

OMRON shall not be responsible for conformity with any standards, codes, or regulations that apply to the combination of products in the customer's application or use of the product.

At the customer's request, OMRON will provide applicable third party certification documents identifying ratings and limitations of use that apply to the products. This information by itself is not sufficient for a complete determination of the suitability of the products in combination with the end product, machine, system, or other application or use.

The following are some examples of applications for which particular attention must be given. This is not intended to be an exhaustive list of all possible uses of the products, nor is it intended to imply that the uses listed may be suitable for the products:

- Outdoor use, uses involving potential chemical contamination or electrical interference, or conditions or uses not described in this catalog.
- Nuclear energy control systems, combustion systems, railroad systems, aviation systems, medical equipment, amusement machines, vehicles, safety equipment, and installations subject to separate industry or government regulations.
- Systems, machines, and equipment that could present a risk to life or property.

Please know and observe all prohibitions of use applicable to the products.

NEVER USE THE PRODUCTS FOR AN APPLICATION INVOLVING SERIOUS RISK TO LIFE OR PROPERTY WITHOUT ENSURING THAT THE SYSTEM AS A WHOLE HAS BEEN DESIGNED TO ADDRESS THE RISKS, AND THAT THE OMRON PRODUCT IS PROPERLY RATED AND INSTALLED FOR THE INTENDED USE WITHIN THE OVERALL EQUIPMENT OR SYSTEM.

Disclaimers

CHANGE IN SPECIFICATIONS

Product specifications and accessories may be changed at any time based on improvements and other reasons.

It is our practice to change model numbers when published ratings or features are changed, or when significant construction changes are made. However, some specifications of the product may be changed without any notice. When in doubt, special model numbers may be assigned to fix or establish key specifications for your application on your request. Please consult with your OMRON representative at any time to confirm actual specifications of purchased product.

DIMENSIONS AND WEIGHTS

Dimensions and weights are nominal and are not to be used for manufacturing purposes, even when tolerances are shown.

ERRORS AND OMISSIONS

The information in this catalog has been carefully checked and is believed to be accurate; however, no responsibility is assumed for clerical, typographical, or proofreading errors, or omissions.

PERFORMANCE DATA

Performance data given in this catalog is provided as a guide for the user in determining suitability and does not constitute a warranty. It may represent the result of OMRON's test conditions, and the users must correlate it to actual application requirements. Actual performance is subject to the OMRON Warranty and Limitations of Liability.

PROGRAMMABLE PRODUCTS

OMRON shall not be responsible for the user's programming of a programmable product, or any consequence thereof.

COPYRIGHT AND COPY PERMISSION

This catalog shall not be copied for sales or promotions without permission.

This catalog is protected by copyright and is intended solely for use in conjunction with the product. Please notify us before copying or reproducing this catalog in any manner, for any other purpose. If copying or transmitting this catalog to another, please copy or transmit it in its entirety.