

Detect Labels Regardless of Label Color or Luster, Bottle Color or Clarity

- High-performance circuitry detects wide variety of labels on clear and colored bottles
- IP67 rugged metal body
- 1ms response time, high-speed production
- NPN, PNP, L.O., D.O. in one unit (switch-selectable)
- Quick-disconnect or cabled models available



## Ordering Information

### ■ E3S-CD68/CD63 LABEL DETECTION SENSOR

Connections	Supply voltage	Sensing type	Sensing range	Output		Part number
				Type	Mode	
M12 quick disconnect	10 to 30 VDC	Diffuse	40 mm ±10 mm	NPN and PNP, switch-selectable	L.O. and D.O., switch-selectable	<b>E3S-CD68</b>
2-meter attached cable						<b>E3S-CD63</b>

Note: Accessories included: mounting bracket, screwdriver and M4 hex bolts. Cable must be ordered separately.

### ■ ACCESSORIES (ORDER SEPARATELY)

Description			Part number
Cables	2 m, 1-connector	3-conductor	<b>XS2F-D421-DC0-A</b>
	5 m, 1-connector	3-conductor	<b>XS2F-D421-GC0-A</b>
Mounting bracket (included w/sensor)	±20° angle adjustment		<b>E39-L113</b>

# Specifications

Part number	E3S-CD68	E3S-CD63
Method of detecting	Diffuse	
Supply voltage	10 to 30 VDC ripple 10% max.	
Current consumption	40 mA	
Sensing distance (See Note 2.)	40 mm $\pm$ 10 mm	
Light source	Infrared LED (880 nm)	
Mode	L.O. and D.O., switch-selectable	
Sensitivity adjustment	2-turn potentiometer	
Output	NPN and PNP, switch selectable	
Capacity	30 VDC, 100 mA; residual voltage, NPN 1.2 V, PNP 2.0 V	
Hysteresis	20% max. of sensing distance	
Response time	1 ms on, 1 ms off	
Circuit protection	Reverse polarity and short circuit protection	
Indicators	Red: Light received; Green: Stability	
Material	Case	Die-cast zinc
	Panel	Sulfonated polyether
	Lens	Acrylic
	Bracket	Stainless steel
Connection	Quick-disconnect M12	2-meter attached cable
Cable bending radius	—	25 mm min.
Weight	76 g	115 g (with 2-m cable)
Enclosure rating	IEC: IP67; NEMA 6P	
Ambient light immunity	Incandescent: 5,000 lx max.	
	Sunlight: 10,000 lx max.	
	Mutual interference protection (See Note 3.)	
Ambient operating temperature	-25°C to 55°C (-13°F to 131°F) no icing	
Relative operating humidity	35% to 85% RH	
Insulation resistance	20 M $\Omega$ min. at 500 VDC	
Dielectric strength	1,000 VAC, 50/60 Hz for 1 min.	
Vibration resistance	10–2000 Hz, 1.5 mm double amplitude, or 300 m/s <sup>2</sup> (approx. 30 G) for 0.6 hours in X, Y, Z axes	
Shock resistance	1 m/s <sup>2</sup> (approx, 100G) 3 times, X, Y, Z axes	

Note: 1. Accessories included: Mounting bracket, screwdriver, M4 hex bolts and instruction sheet.

2. With Kodak 18% grey card, 20 x 20 mm.

3. Mutual Interference Protection: Allows sensor to filter out interfering light sources from nearby sensors and avoid interference.

# Engineering Data

## ■ OPERATING RANGE (TYPICAL)

E3S-CD68/CD63 (Horizontal)

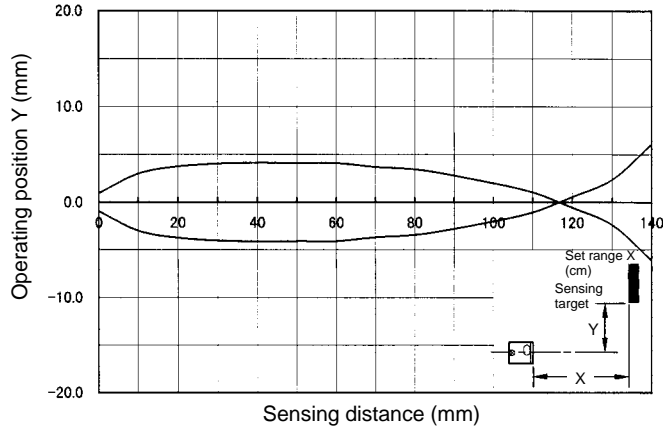

## ■ EXCESS GAIN VS. SET DISTANCE (TYPICAL)

E3S-CD68/CD63 (Horizontal)

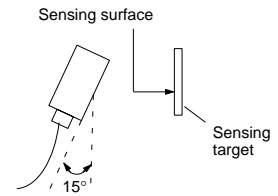
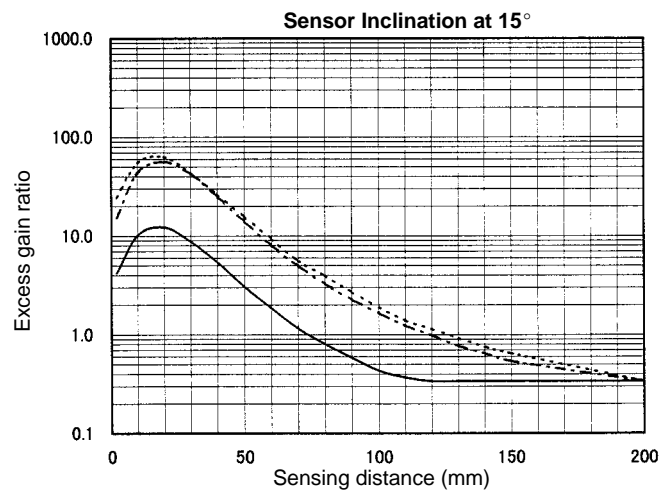
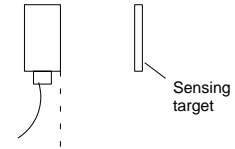
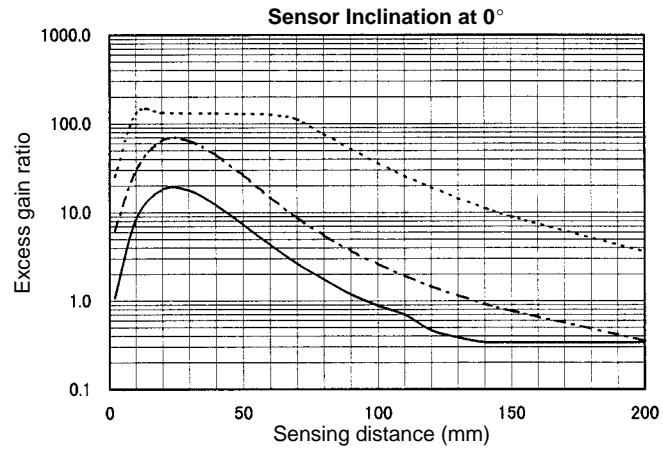

# Dimensions

Unit: mm (inch)

## ■ E3S-CD68

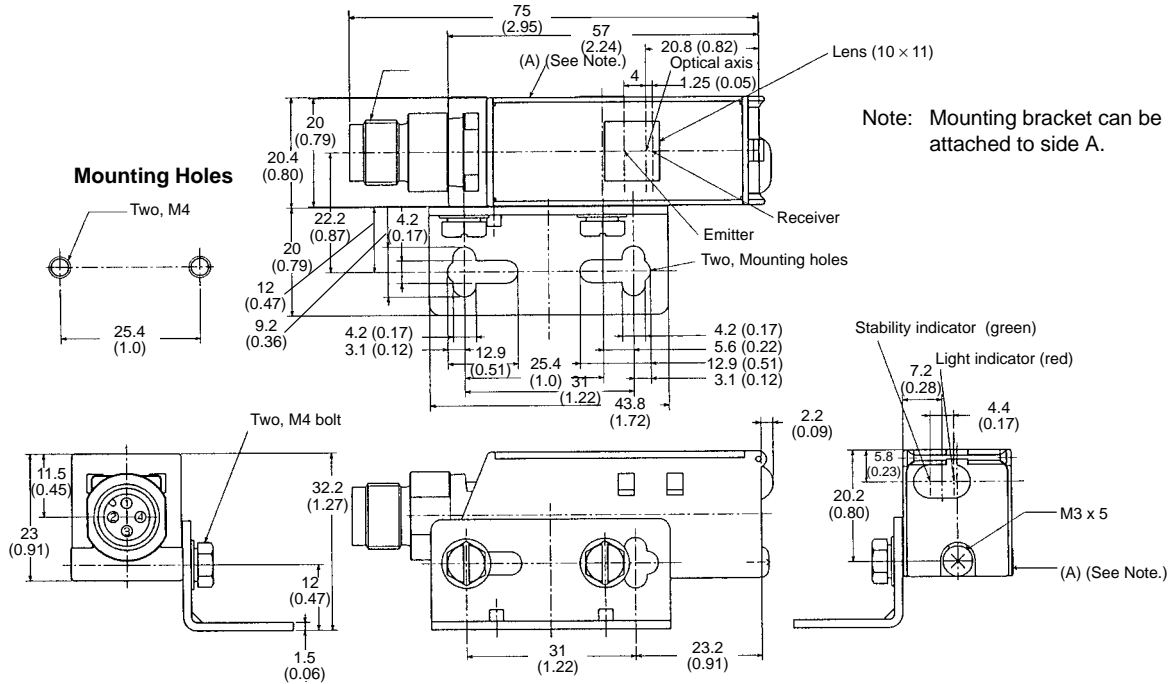

## ■ E3S-CD63

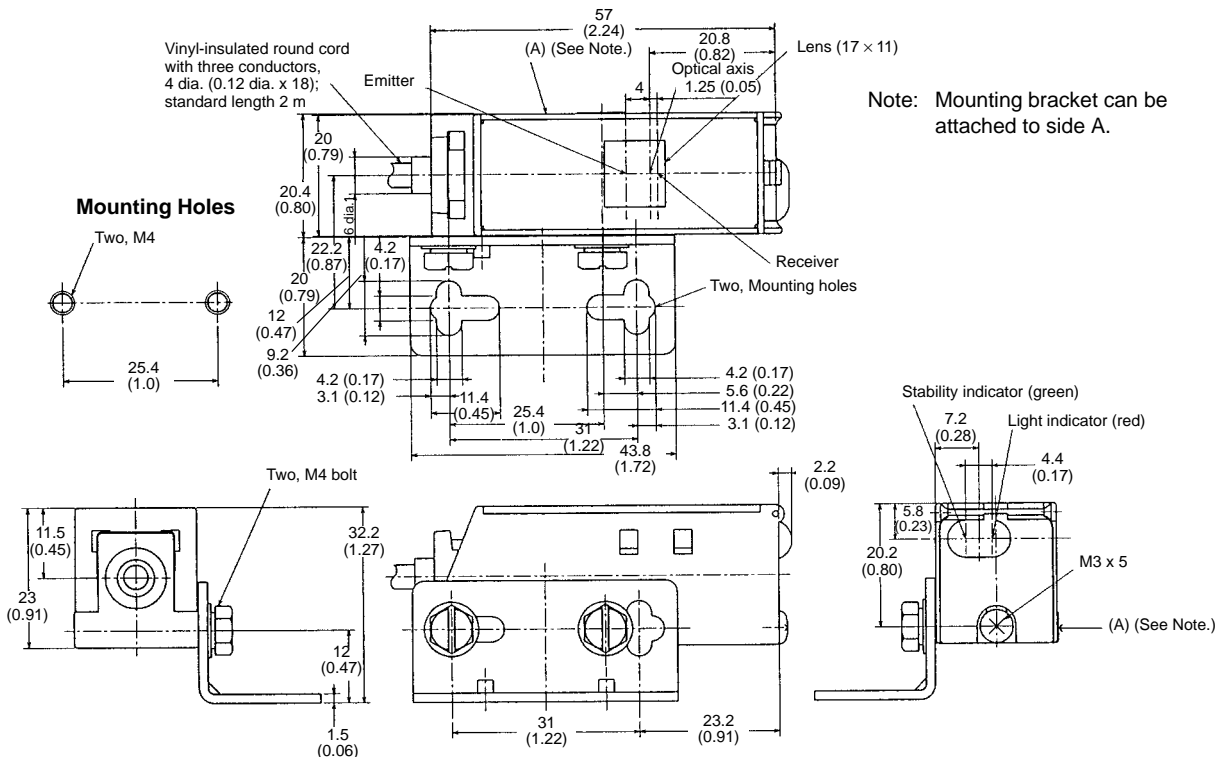

■ ACCESSORIES

E39-L113 Mounting Bracket

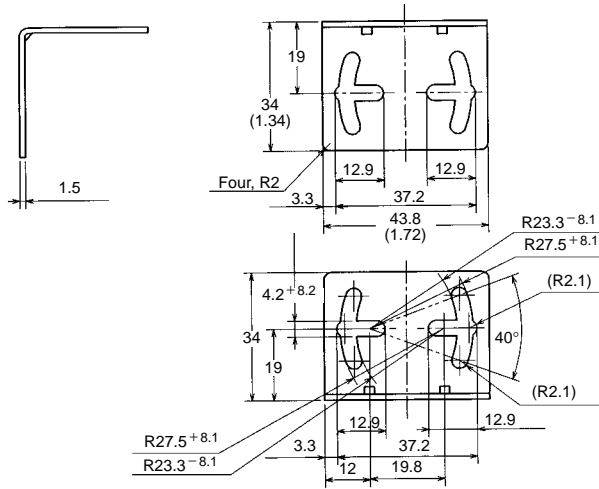

Mounting Example

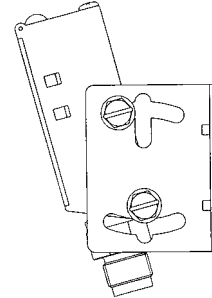

Note: If the load is a relay, insert an arc suppressor across the coils of the relay. The connection example is for Sensors with the NPN output.

Installation

■ CONNECTIONS

Wiring Diagram (NPN Selection Shown)

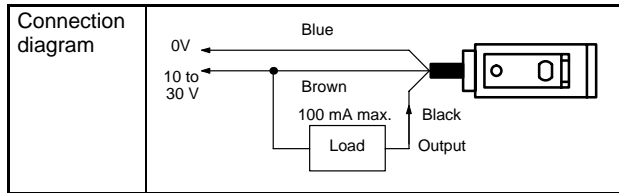

(With Sensor Controller (S3D2))

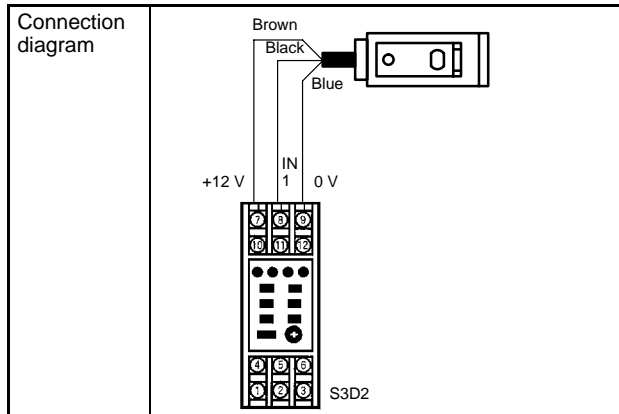

WIRING DIAGRAM

Label Sensor

Output configuration	Mode selector	Output transistor	Output circuits
NPN	Light-ON	On when light is received.	<p>ZD : <math>V_Z = 39\text{ V}</math> Note: Set the NPN or PNP output selector to NPN.</p> <p><b>Connector Pin Arrangement</b></p>
	Dark-ON	ON when light is not received.	<p>ZD : <math>V_Z = 39\text{ V}</math> Note: Set the NPN or PNP output selector to NPN.</p> <p><b>Connector Pin Arrangement</b></p>
PNP	Light-ON	On when light is received.	<p>ZD : <math>V_Z = 39\text{ V}</math> Note: Set the NPN or PNP output selector to PNP.</p> <p><b>Connector Pin Arrangement</b></p>
	Dark-ON	ON when light is not received.	<p>ZD : <math>V_Z = 39\text{ V}</math> Note: Set the NPN or PNP output selector to PNP.</p> <p><b>Connector Pin Arrangement</b></p>

I/O Connector Plug

NPN Output

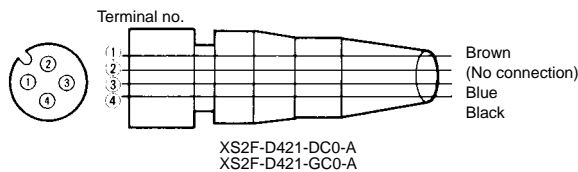

PNP Output

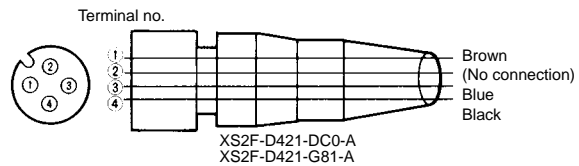

NPN output				PNP output			
Type	Conductor	Connector pin	Application	Type	Conductor	Connector pin	Application
DC	Brown	1	Power supply (+V)	DC	Brown	1	Power supply (+V)
	Black	4	Output		Black	4	Output
	Blue	3	Power supply (0 V)		Blue	3	Power supply (0 V)
	---	2	No connection		---	2	No connection

# Nomenclature

## MODE SELECT

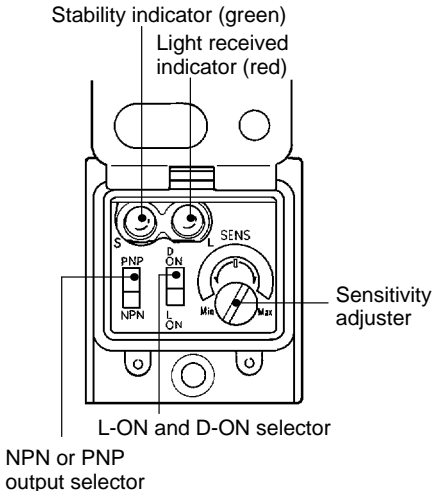

















## OPERATION PANEL

Use the NPN or PNP output selector on the operation panel to select the type of output transistor.

Use the Light-ON or Dark-ON selector on the operation panel to select the operation mode of the E3S-CD68/CD63.

# Operation

## ■ TIMING CHART

Output configuration	Mode selector	Output transistor	Timing chart
NPN	Light-ON	On when light is received.	Light received Light not received  Light indicator (Red) ON OFF  Output transistor ON OFF  Load (relay) Operate Release  (Between terminals 1 and 4 or between brown and black)
	Dark-ON	ON when light is not received.	Light received Light not received  Light indicator (Red) ON OFF  Output transistor ON OFF  Load (relay) Operate Release  (Between terminals 1 and 4 or between brown and black)
PNP	Light-ON	On when light is received.	Light received Light not received  Light indicator (Red) ON OFF  Output transistor ON OFF  Load (relay) Operate Release  (Between terminals 3 and 4 or between black and blue)
	Dark-ON	ON when light is not received.	Light received Light not received  Light indicator (Red) ON OFF  Output transistor ON OFF  Load (relay) Operate Release  (Between terminals 3 and 4 or between black and blue)

## ■ ALIGNMENT AND SENSITIVITY ADJUSTMENT

### Alignment

1. Adjust the mounting angle of the Label Sensor as shown below until it is located in a position where it will not be affected by target objects.
2. Label detection will become stable when the Sensor is inclined by 15°.
3. Align the target label center to the optical axis of the Label Sensor.

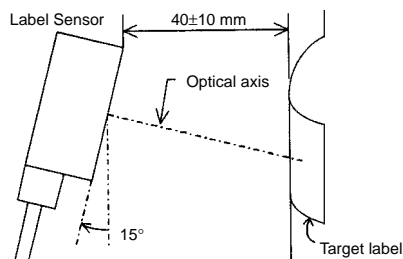



### Sensitivity Adjustment

Following the optical axis adjustment, carry out the sensitivity adjustment as shown below if detection is unstable due to influences from labels located on the other side of sensing bottle surfaces or bottle materials.

Item	Position A	Position B	Setting
Sensing condition			---
Sensitivity adjustor			
Indicators	ON to OFF  STABILITY (green)    OFF to ON  LIGHT (red)	ON to OFF  STABILITY (green)    ON to OFF  LIGHT (red)	ON  STABILITY (green)    OFF  LIGHT (red)
Procedure	Place a target bottle label at the specified position. Set the sensitivity adjustor to the minimum scale position and gradually increase sensitivity by turning the sensitivity adjustor clockwise until the light indicator (red LED) turns ON. Position A is where the light indicator has turned ON.	Place a bottle without a label at the specified position. Set the sensitivity adjustor to the maximum scale position and gradually decrease sensitivity by turning the sensitivity adjustor counterclockwise until the light indicator turns OFF. Position B is where the light indicator has turned OFF.	Set the sensitivity indicator to the middle position between positions A and B.

### INDICATORS

Status	Indicators	ON/OFF as indicated by the red indicator	Excess gain as indicated by the green indicator for temperature changes	Excess gain
Stable ON	Green     Red	ON (Red indicator is ON.)	Stable detection is possible at the rated temperature range. (Green indicator is ON.)	— Operating level x 1.2 —
Unstable ON	Green     Red			
Unstable OFF	Green     Red	OFF (Red indicator is OFF.)		— Operating level —
Stable OFF	Green     Red		Stable detection is possible at the rated temperature range. (Green indicator is ON.)	— Operating level x 0.8 —

### MUTUAL INTERFERENCE PROTECTION

If Photoelectric Sensors are installed side by side, each Photoelectric Sensor may be influenced by the light emitted from other Photoelectric Sensors.

The fuzzy mutual interference prevention function of the E3S-C enables the E3S-C to monitor any light interference for a certain period before the E3S-C starts emitting light so that the E3S-C can retrieve the intensity and frequency of the light interference as data. Using this data, the E3S-C estimates with fuzzy inference the risk of the malfunctioning of the E3S-C and controls the timing of the E3S-C's light emission.

When the risk is low: The E3S-C waits until there is no light interference and emits light.

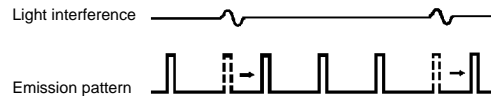

When the risk is high:  
The E3S-C emits light between each light interference moment.

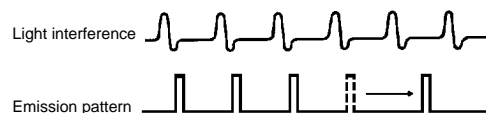

## ■ SETTINGS

### Bottles

In the case of transparent bottles, target labels may not be stably detected due to influences from labels located on the other side of the bottle and colored substances contained in the bottles.

Since label detection depends on the label or bottle materials and color combination, be sure to confirm that detection is possible by using an actual product.

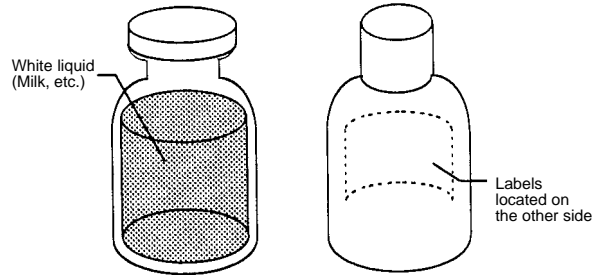

## Precautions

### ■ CONNECTION

To avoid malfunction or damage, do not place the input/output lines of the Label Sensor in the same conduit as power lines. Either separate the wiring, or use shielded lines as input/output lines to the Label Sensor.

The cable connected to the E3S-CD68/CD63 can be extended up to 100 m, provided that the diameter of each wire of the cable is a minimum of 0.3 mm<sup>2</sup>.

### ■ STARTUP OPERATION

A maximum of 100 ms is required from the time power is turned on until the E3S-CD68/CD63 is able to detect objects.

If power is supplied to the loads and the E3S-CD68/CD63 from different sources, turn on power to the E3S-CD68/CD63 first.

### ■ POWER SUPPLY

If a standard switching regulator is used as a power supply, the frame ground (FG) terminal and the ground (G) terminal must be grounded, to avoid malfunction due to the switching noise of the power supply.

If an inverter motor or servomotor is used with the E3S-CD68/CD63, the frame ground (FG) terminal and the ground (G) terminal must be grounded, or the E3S-CD68/CD63 may malfunction.

### ■ WATER RESISTANCE

Do not use the E3S-CD68/CD63 in water, in the rain, or outdoors.

To ensure the water resistance of the E3S-CD68/CD63, tighten the screws of the operation panel cover to a torque of 3.5 to 5.5 kgf • cm (0.34 N • m to 0.54 N • m).

### ■ OIL AND CHEMICAL RESISTANCE

Do not use the E3S-CD68/CD63 in oils or liquid chemicals.

### ■ CABLE

The E3S-CD68/CD63 uses an oil-resistant cable to ensure oil resistance.

Do not allow the cable to be repeatedly bent during application.

Do not allow the cable to be bent to a radius of less than 25 mm.

### ■ MOUNTING

When mounting the E3S-CD68/CD63, avoid heavy impact (see shock and vibration specifications) which may damage sensor and void warranty.

Use M4 screws to mount the E3S-CD68/CD63.

The tightening torque of each screw must be: 3.5 to 5.5 kgf • cm (36.4 to 60.2 in • lb) maximum.

#### Mounting Bracket

When mounting the E3S-CD68/CD63 with the mounting bracket so that sensing targets will be in the direction of the mechanical axis, use the optical axis lock holes.

If it is not possible to mount the E3S-CD68/CD63 so that the sensing targets will be in the direction of the mechanical axis, move the E3S-CD68/CD63 upwards, downwards, to the left, or to the right. Secure the E3S-CD68/CD63 in the center of the range where the light indicator will be lit and make sure that the stability indicator is lit.

#### Direct Mounting

Mount the E3S-CD68/CD63 as shown in the following illustration.

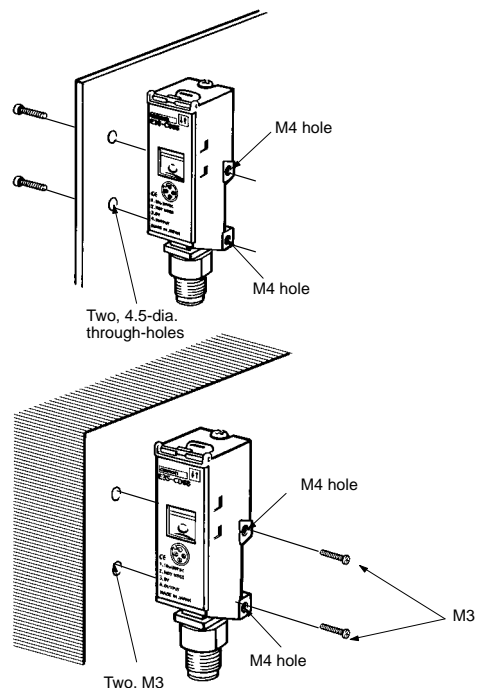

**NOTE: DIMENSIONS SHOWN ARE IN MILLIMETERS. To convert millimeters to inches divide by 25.4.**

**OMRON**<sup>®</sup>  
**OMRON ELECTRONICS, INC.**  
One East Commerce Drive  
Schaumburg, IL 60173  
**1-800-55-OMRON**

**OMRON CANADA, INC.**  
885 Milner Avenue  
Scarborough, Ontario M1B 5V8  
**416-286-6465**