

### A New Series of Easy-to-use and Tough E2E/E2E2 Models

#### Long-size E2E2 Proximity Sensor Conforms to CENELEC

- Ideal for a variety of applications.
- With a metal connector that can be tightened securely and a cord protector.
- With an easy-to-see indicator, deeper mounting holes, and tightening flats for wrenches.
- The new series of E2E models includes M8 plug-in connector models.

**Note:** Detailed information is available for the replacement of conventional E2E models with new E2E models. Ask your OMRON representative for a copy of OMRON's E2E/E2E2 Conversion Guide.



## Ordering Information

### E2E

#### DC 2-wire/Pre-wired Models

Self-diagnostic output function	Type	Size	Sensing distance	Part number	
				NO	NC
Yes	Shielded	M12	3 mm	E2E-X3D1S (see note 1)	---
		M18	7 mm	E2E-X7D1S (see note 1)	---
		M30	10 mm	E2E-X10D1S (see note 1)	---
	Unshielded	M12	8 mm	E2E-X8MD1S (see note 1)	---
		M18	14 mm	E2E-X14MD1S (see note 1)	---
		M30	20 mm	E2E-X20MD1S (see note 1)	---
No	Shielded	M8	2 mm	E2E-X2D1-N (see notes 1 and 2)	E2E-X2D2-N
		M12	3 mm	E2E-X3D1-N (see notes 1 and 2)	E2E-X3D2-N
		M18	7 mm	E2E-X7D1-N (see notes 1 and 2)	E2E-X7D2-N
		M30	10 mm	E2E-X10D1-N (see notes 1 and 2)	E2E-X10D2-N
	Unshielded	M8	4 mm	E2E-X4MD1 (see notes 1 and 2)	E2E-X4MD2
		M12	8 mm	E2E-X8MD1 (see notes 1 and 2)	E2E-X8MD2
		M18	14 mm	E2E-X14MD1 (see notes 1 and 2)	E2E-X14MD2
		M30	20 mm	E2E-X20MD1 (see notes 1 and 2)	E2E-X20MD2



- Note:**
1. In addition to the above models, E2E-X□□15 models (e.g., E2E-X3D15-N), which are different in frequency from the above models, are available.
  2. E2E models with a robotics cable are available as well. The model number of a model with a robotics cable has the suffix "-R" (e.g., E2E-X3D1-R).

## DC 2-wire/Plug-in Models

Connector	Self-diagnostic output function	Type	Size	Sensing distance	Part number	
					NO	NC
M12	Yes	Shielded	M12	3 mm	E2E-X3D1S-M1	---
			M18	7 mm	E2E-X7D1S-M1	---
			M30	10 mm	E2E-X10D1S-M1	---
		Unshielded	M12	8 mm	E2E-X8MD1S-M1	---
			M18	14 mm	E2E-X14MD1S-M1	---
			M30	20 mm	E2E-X20MD1S-M1	---
	No	Shielded	M8	2 mm	E2E-X2D1-M1G	E2E-X2D2-M1G
			M12	3 mm	E2E-X3D1-M1G (see note)	E2E-X3D2-M1G
			M18	7 mm	E2E-X7D1-M1G (see note)	E2E-X7D2-M1G
			M30	10 mm	E2E-X10D1-M1G (see note)	E2E-X10D2-M1G
		Unshielded	M8	4 mm	E2E-X4MD1-M1G	E2E-X4MD2-M1G
			M12	8 mm	E2E-X8MD1-M1G (see note)	E2E-X8MD2-M1G
			M18	14 mm	E2E-X14MD1-M1G (see note)	E2E-X14MD2-M1G
			M30	20 mm	E2E-X20MD1-M1G (see note)	E2E-X20MD2-M1G
M8		Shielded	M8	2 mm	E2E-X2D1-M3G	E2E-X2D2-M3G
		Unshielded		4 mm	E2E-X3D1-M3G	E2E-X3D2-M3G

**Note:** In addition to the above models, E2E-X□□D15□□-M1G models (e.g., E2E-X3D15-M1G), which are different in frequency from the above models, are available

## DC 2-wire/Connector Extension Models

Type	Size	Sensing distance	Output configuration	Polarity	Part number	
Shielded 	M12	3 mm	NO	Yes	E2E-X3D1-M1GJ	
				No	E2E-X3D1-M1J-T	
				Yes	E2E-X7D1-M1GJ	
	M18	7 mm		No	E2E-X7D1-M1J-T	
				Yes	E2E-X10D1-M1GJ	
				No	E2E-X10D1-M1J-T	
Unshielded 	M12	8 mm	NO	Yes	E2E-X8MD1-M1GJ	
					E2E-X14MD1-M1GJ	
					E2E-X20MD1-M1GJ	
	M18	14 mm		NO		E2E-X14MD1-M1GJ
						E2E-X14MD2-M1G
						E2E-X20MD1-M1GJ
M30	20 mm	NO			E2E-X20MD1-M1GJ	
					E2E-X20MD2-M1G	
					E2E-X20MD1-M1GJ	

**Note:** 1. A model with no polarity has a residual voltage of 5 V, which must be taken into consideration together with the interface condition (the PC's ON voltage, for example) when connecting the Proximity Sensor to a load.

2. The standard cord length is 30 cm. 50-cm and 1-m models are also available.

## Connector Pin Assignments of DC 2-wire Model

The connector pin assignments of each new E2E DC 2-wire conforms to IEC947-5-2 Table III.

The following E2E models with conventional connector pin assignments are available as well.

Type	Size	Output configuration	Part number	Sensing head		Output configuration	Part number
Shielded	M8	NO	E2E-X2D1-M1	Unshielded	M8	NO	E2E-X4MD1-M1
		NC	E2E-X2D2-M1			NC	E2E-X4MD2-M1
	M12	NO	E2E-X3D1-M1		M12	NO	E2E-X8MD1-M1
		NC	E2E-X3D2-M1			NC	E2E-X8MD2-M1
	M18	NO	E2E-X7D1-M1		M18	NO	E2E-X14MD1-M1
		NC	E2E-X7D2-M1			NC	E2E-X14MD2-M1
	M30	NO	E2E-X10D1-M1		M30	NO	E2E-X20MD1-M1
		NC	E2E-X10D2-M1			NC	E2E-X20MD2-M1

## DC 3-wire/Pre-wired Models

Type	Size	Sensing distance	Output configuration	Part number			
Shielded	4 dia.*	0.8 mm	NPN NO	E2E-CR8C1 (see note 2)			
			NPN NC	E2E-CR8C2			
			PNP NO	E2E-CR8B1			
	M5*	1 mm	NPN NO	E2E-X1C1 (see note 2)			
			NPN NC	E2E-X1C2			
			PNP NO	E2E-X1B1			
	5.4 dia.*	1 mm	NPN NO	E2E-C1C1 (see note 2)			
			NPN NC	E2E-C1C2			
			PNP NO	E2E-C1B1			
	M8	1.5 mm	NPN NO	E2E-X1R5E1 (see note 2)			
			NPN NC	E2E-X1R5E2			
			PNP NO	E2E-X1R5F1 (see note 2)			
			PNP NC	E2E-X1R5F2			
			M12	2 mm	NPN NO	E2E-X2E1 (see notes 1 and 2)	
					NPN NC	E2E-X2E2	
	PNP NO	E2E-X2F1 (see note 2)					
			PNP NC	E2E-X2F2			
			M18	5 mm	NPN NO	E2E-X5E1 (see notes 1 and 2)	
					NPN NC	E2E-X5E2	
	PNP NO	E2E-X5F1 (see note 2)					
			PNP NC	E2E-X5F2			
			M30	10 mm	NPN NO	E2E-X10E1 (see notes 1 and 2)	
					NPN NC	E2E-X10E2	
	PNP NO	E2E-X10F1 (see note 2)					
		PNP NC	E2E-X10F2				
		Un-shielded	M8	2 mm	NPN NO	E2E-X2ME1 (see note 2)	
					NPN NC	E2E-X2ME2	
PNP NO	E2E-X2MF1 (see note 2)						
PNP NC	E2E-X2MF2						
				M12	5 mm	NPN NO	E2E-X5ME1 (see notes 1 and 2)
						NPN NC	E2E-X5ME2
						PNP NO	E2E-X5MF1 (see note 2)
						PNP NC	E2E-X5MF2
				M18	10 mm	NPN NO	E2E-X10ME1 (see notes 1 and 2)
						NPN NC	E2E-X10ME2
						PNP NO	E2E-X10MF1 (see note 2)
						PNP NC	E2E-X10MF2

Type	Size	Sensing distance	Output configuration	Part number
Un-shielded	M30	18 mm	NPN NO	E2E-X18ME1 (see notes 1 and 2)
			NPN NC	E2E-X18ME2
			PNP NO	E2E-X18MF1 (see note 2)
			PNP NC	E2E-X18MF2

- Note:**
1. In addition to the above models, E2E-X□E15 models (e.g., E2E-X5E15), which are different in frequency from the above models, are available.
  2. E2E DC 3-wire with a robotics cable are available as well. The model number of a model with a robotics cable has the suffix "-R" (e.g., E2E-X5E1-R).
  3. Those marked with "\*" are not subject to any design change and are the same as the conventional models.

## AC 2-wire/Pre-wired Models

Type	Size	Sensing distance	Output configuration	Part number	
Shielded	M8	1.5 mm	NO	E2E-X1R5Y1	
			NC	E2E-X1R5Y2	
	M12	2 mm	NO	E2E-X2Y1	
			NC	E2E-X2Y2	
	M18	5 mm	NO	E2E-X5Y1 (see note)	
			NC	E2E-X5Y2	
	M30	10 mm	NO	E2E-X10Y1 (see note)	
			NC	E2E-X10Y2	
	Un-shielded	M8	2 mm	NO	E2E-X2MY1 (see note)
				NC	E2E-X2MY2
		M12	5 mm	NO	E2E-X5MY1 (see note)
				NC	E2E-X5MY2
M18		10 mm	NO	E2E-X10MY1 (see note)	
			NC	E2E-X10MY2	
M30		18 mm	NO	E2E-X18MY1 (see note)	
			NC	E2E-X18MY2	

- Note:** In addition to the above models, E2E-X□Y15 models (e.g., E2E-X5Y15), which are different in frequency from the above models, are available.

## DC 3-wire/Plug-in Models

Connector	Type	Size	Sensing distance	Output configuration	Part number			
M12	Shielded	M8	1.5 mm	NPN NO	E2E-X1R5E1-M1			
				NPN NC	E2E-X1R5E2-M1			
				PNP NO	E2E-X1R5F1-M1			
				PNP NC	E2E-X1R5F2-M1			
		M12	2 mm	NPN NO	E2E-X2E1-M1			
				NPN NC	E2E-X2E2-M1			
				PNP NO	E2E-X2F1-M1			
				PNP NC	E2E-X2F2-M1			
				M18	5 mm	NPN NO	E2E-X5E1-M1	
						NPN NC	E2E-X5E2-M1	
		PNP NO	E2E-X5F1-M1					
		PNP NC	E2E-X5F2-M1					
		M30	10 mm	NPN NO	E2E-X10E1-M1			
				NPN NC	E2E-X10E2-M1			
				PNP NO	E2E-X10F1-M1			
				PNP NC	E2E-X10F2-M1			
				Un-shielded	M8	2 mm	NPN NO	E2E-X2ME1-M1
							NPN NC	E2E-X2ME2-M1
							PNP NO	E2E-X2MF1-M1
							PNP NC	E2E-X2MF2-M1
	M12	5 mm	NPN NO		E2E-X5ME1-M1			
			NPN NC		E2E-X5ME2-M1			
			PNP NO		E2E-X5MF1-M1			
			PNP NC		E2E-X5MF2-M1			
	M18	10 mm	NPN NO		E2E-X10ME1-M1			
			NPN NC		E2E-X10ME2-M1			
			PNP NO		E2E-X10MF1-M1			
			PNP NC		E2E-X10MF2-M1			
	M30	18 mm	NPN NO	E2E-X18ME1-M1				
			NPN NC	E2E-X18ME2-M1				
			PNP NO	E2E-X18MF1-M1				
			PNP NC	E2E-X18MF2-M1				
	M8 (see note 2)	Shielded	M8	1.5 mm	NPN NO	E2E-X1R5E1-M3		
					NPN NC	E2E-X1R5E2-M3		
					PNP NO	E2E-X1R5F1-M3		
					PNP NC	E2E-X1R5F2-M3		
		Un-shielded	M8	2 mm	NPN NO	E2E-X2ME1-M3		
					NPN NC	E2E-X2ME2-M3		
					PNP NO	E2E-X2MF1-M3		
					PNP NC	E2E-X2MF2-M3		

- Note:** 1. The material has been changed from plastic, "-P1," to metal, "-M1."  
2. New addition to the product line-up.

## AC 2-wire/Plug-in Models

Type	Size	Sensing distance	Output configuration	Part number
Shielded	M12	2 mm	NO	E2E-X2Y1-M1
			NC	E2E-X2Y2-M1
	M18	5 mm	NO	E2E-X5Y1-M1
			NC	E2E-X5Y2-M1
	M30	10 mm	NO	E2E-X10Y1-M1
			NC	E2E-X10Y2-M1
Un-shielded	M12	5 mm	NO	E2E-X5MY1-M1
			NC	E2E-X5MY2-M1
	M18	10 mm	NO	E2E-X10MY1-M1
			NC	E2E-X10MY2-M1
	M30	18 mm	NO	E2E-X18MY1-M1
			NC	E2E-X18MY2-M1



**Note:** The material has been changed from plastic, "-P1," to metal, "-M1."

## AC/DC 2-wire Models

Type	Size	Sensing distance	Output configuration	Part number
Shielded	M12	3 mm	NO	E2E-X3T1
	M18	7 mm		E2E-X7T1
	M30	10 mm		E2E-X10T1



**Note:** The last two characters, "-1," are omitted from the model names.

**E2E2****DC 2-wire Models**



Type	Size	Sensing distance	Output configuration	Part number
Shielded 	M12	3 mm	NO (see note)	E2E2-X3D1
			NC	E2E2-X3D2
	M18	7 mm	NO (see note)	E2E2-X7D1
			NC	E2E2-X7D2
	M30	10 mm	NO (see note)	E2E2-X10D1
			NC	E2E2-X10D2
Unshielded 	M12	8 mm	NO (see note)	E2E2-X8MD1
			NC	E2E2-X8MD2
	M18	14 mm	NO (see note)	E2E2-X14MD1
			NC	E2E2-X14MD2
	M30	20 mm	NO (see note)	E2E2-X20MD1
			NC	E2E2-X20MD2

**Note:** In addition to the above models, E2E-X□D15 models (e.g., E2E-X3D15), which are different in frequency from the above models, are available.



**DC 3-wire/Pre-wired Models**

Type	Size	Sensing distance	Output configuration	Part number
Shielded 	M12	2 mm	NPN NO	E2E2-X2C1
			NPN NC	E2E2-X2C2
			PNP NO	E2E2-X2B1
			PNP NC	E2E2-X2B2
	M18	5 mm	NPN NO	E2E2-X5C1
			NPN NC	E2E2-X5C2
			PNP NO	E2E2-X5B1
			PNP NC	E2E2-X5B2
	M30	10 mm	NPN NO	E2E2-X10C1
			NPN NC	E2E2-X10C2
			PNP NO	E2E2-X10B1
			PNP NC	E2E2-X10B2
Unshielded 	M12	5 mm	NPN NO	E2E2-X5MC1
			NPN NC	E2E2-X5MC2
			PNP NO	E2E2-X5MB1
			PNP NC	E2E2-X5MB2
	M18	10 mm	NPN NO	E2E2-X10MC1
			NPN NC	E2E2-X10MC2
			PNP NO	E2E2-X10MB1
			PNP NC	E2E2-X10MB2
	M30	18 mm	NPN NO	E2E2-X18MC1
			NPN NC	E2E2-X18MC2
			PNP NO	E2E2-X18MB1
			PNP NC	E2E2-X18MB2



## DC 3-wire/Connector Models

Type	Size	Sensing distance	Output configuration	Part number
Shielded 	M12	2 mm	NPN NO	E2E2-X2C1-M1
			NPN NC	E2E2-X2C2-M1
			PNP NO	E2E2-X2B1-M1
			PNP NC	E2E2-X2B2-M1
	M18	5 mm	NPN NO	E2E2-X5C1-M1
			NPN NC	E2E2-X5C2-M1
			PNP NO	E2E2-X5B1-M1
			PNP NC	E2E2-X5B2-M1
	M30	10 mm	NPN NO	E2E2-X10C1-M1
			NPN NC	E2E2-X10C2-M1
			PNP NO	E2E2-X10B1-M1
			PNP NC	E2E2-X10B2-M1
Unshielded 	M12	5 mm	NPN NO	E2E2-X5MC1-M1
			NPN NC	E2E2-X5MC2-M1
			PNP NO	E2E2-X5MB1-M1
			PNP NC	E2E2-X5MB2-M1
	M18	10 mm	NPN NO	E2E2-X10MC1-M1
			NPN NC	E2E2-X10MC2-M1
			PNP NO	E2E2-X10MB1-M1
			PNP NC	E2E2-X10MB2-M1
	M30	18 mm	NPN NO	E2E2-X18MC1-M1
			NPN NC	E2E2-X18MC2-M1
			PNP NO	E2E2-X18MB1-M1
			PNP NC	E2E2-X18MB2-M1

## AC 2-wire/Pre-wired Models

Type	Size	Sensing distance	Output configuration	Part number
Shielded 	M12	2 mm	NO	E2E2-X2Y1
			NC	E2E2-X2Y2
	M18	5 mm	NO	E2E2-X5Y1
			NC	E2E2-X5Y2
	M30	10 mm	NO	E2E2-X10Y1
			NC	E2E2-X10Y2
Unshielded 	M12	5 mm	NO	E2E2-X5MY1
			NC	E2E2-X5MY2
	M18	10 mm	NO	E2E2-X10MY1
			NC	E2E2-X10MY2
	M30	18 mm	NO	E2E2-X18MY1
			NC	E2E2-X18MY2

## AC 2-wire/Connector Models

Type	Size	Sensing distance	Output configuration	Part number
Shielded 	M12	2 mm	NO	E2E2-X2Y1-M4
			NC	E2E2-X2Y2-M4
	M18	5 mm	NO	E2E2-X5Y1-M4
			NC	E2E2-X5Y2-M4
	M30	10 mm	NO	E2E2-X10Y1-M4
			NC	E2E2-X10Y2-M4
Unshielded 	M12	5 mm	NO	E2E2-X5MY1-M4
			NC	E2E2-X5MY2-M4
	M18	10 mm	NO	E2E2-X10MY1-M4
			NC	E2E2-X10MY2-M4
	M30	18 mm	NO	E2E2-X18MY1-M4
			NC	E2E2-X18MY2-M4

# Specifications

## ■ Ratings/Characteristics

### E2E

#### E2E-X□D□ DC 2-wire Models

Item	E2E-X2D□	E2E-X4MD□	E2E-X3D□	E2E-X8MD□	E2E-X7D□	E2E-X14MD□	E2E-X10D□	E2E-X20MD□
Size	M8		M12		M18		M30	
Type	Shielded	Unshielded	Shielded	Unshielded	Shielded	Unshielded	Shielded	Unshielded
Sensing distance	2 mm ±10%	4 mm ±10%	3 mm ±10%	8 mm ±10%	7 mm ±10%	14 mm ±10%	10 mm ±10%	20 mm ±10%
Supply voltage (operating voltage range)	12 to 24 VDC, ripple (p-p): 10% max., (10 to 30 VDC)							
Leakage current	0.8 mA max.							
Sensing object	Ferrous metal (refer to <i>Engineering Data</i> for non-ferrous metal)							
Setting distance	0 to 1.6 mm	0 to 3.2 mm	0 to 2.4 mm	0 to 6.4 mm	0 to 5.6 mm	0 to 11.2 mm	0 to 8.0 mm	0 to 16.0 mm
Standard object (mild steel)	8 x 8 x 1 mm	20 x 20 x 1 mm	12 x 12 x 1 mm	30 x 30 x 1 mm	18 x 18 x 1 mm	30 x 30 x 1 mm	30 x 30 x 1 mm	54 x 54 x 1 mm
Differential travel	15% max. of sensing distance		10% max. of sensing distance					
Response frequency	1.5 kHz	1.0 kHz	1.0 kHz	0.8 kHz	0.5 kHz	0.4 kHz	0.4 kHz	0.1 kHz
Operation (with sensing object approaching)	D1 models: Load ON D2 models: Load OFF							
Control output (switching capacity)	3 to 100 mA (5 to 100 mA for -M1J-T models) Diagnostic output: 50 mA for -D1S models							
Diagnostic output delay	0.3 to 1 s							
Circuit protection	Surge absorber, load short-circuit protection (for control and diagnostic output)							
Indicator	D1 models: Operation indicator (red LED), operation set indicator (green LED) D2 models: Operation indicator (red LED)							
Ambient temperature	Operating: -25°C to 70°C (with no icing)							
Ambient humidity	Operating: 35% to 95%							
Temperature influence	±15% max. of sensing distance at 23°C in temperature range of -25°C to 70°C		±10% max. of sensing distance at 23°C in temperature range of -25°C to 70°C					
Voltage influence	±1% max. of sensing distance in rated voltage range ±15%							
Residual voltage (see note)	3.0 V max. (under load current of 100 mA with cable length of 2 m) 5.0 V min. for -M1J-T models							
Insulation resistance	50 MΩ min. (at 500 VDC) between current carry parts and case							
Dielectric strength	1,000 VAC for 1 min between current carry parts and case							
Vibration resistance	Destruction: 10 to 55 Hz, 1.5-mm double amplitude for 10 times each in X, Y, and Z directions							
Shock resistance	Destruction: 500 m/s <sup>2</sup> (approx. 50G) for 10 times each in X, Y, and Z directions		Destruction: 1,000 m/s <sup>2</sup> (approx. 100G) for 10 times each in X, Y, and Z directions					
Degree of protection	IEC60529 IP67							
Weight	Approx. 45 g		Approx. 120 g		Approx. 160 g		Approx. 220 g	
Material	Case	Stainless steel		Brass				
	Sensing surface	PBT						

**Note:** The residual voltage of each E2E model with the model number suffix "-M1J-T" is 5 V. When connecting an E2E model with the suffix "-M1J-T" to a device, make sure that the device can withstand the residual voltage.



## E2E-X□E□/F□ DC 3-wire Models

Item	E2E-X1R5E□/ F□	E2E-X2ME□ / F□	E2E-X2E□/ F□	E2E-X5ME□ / F□	E2E-X5E□/ F□	E2E-X10ME□/ F□	E2E-X10E□/ F□	E2E-X18ME□/ F□	
Size	M8		M12		M18		M30		
Type	Shielded	Unshielded	Shielded	Unshielded	Shielded	Unshielded	Shielded	Unshielded	
Sensing distance	1.5 mm ±10%	2 mm ±10%	2 mm ±10%	5 mm ±10%	5 mm ±10%	10 mm ±10%	10 mm ±10%	18 mm ±10%	
Supply voltage (operating voltage range) (see note 1)	12 to 24 VDC, ripple (p-p): 10% max., (10 to 40 VDC)								
Current consumption	13 mA max.								
Sensing object	Ferrous metal (refer to <i>Engineering Data</i> for non-ferrous metal)								
Setting distance	0 to 1.2 mm	0 to 1.6 mm	0 to 1.6 mm	0 to 4.0 mm	0 to 4.0 mm	0 to 8.0 mm	0 to 8.0 mm	0 to 14.0 mm	
Standard object (mild steel)	8 x 8 x 1 mm	12 x 12 x 1 mm	12 x 12 x 1 mm	15 x 15 x 1 mm	18 x 18 x 1 mm	30 x 30 x 1 mm	30 x 30 x 1 mm	54 x 54 x 1 mm	
Differential travel	10% max. of sensing distance								
Response frequency	2.0 kHz	0.8 kHz	1.5 kHz	0.4 kHz	0.6 kHz	0.2 kHz	0.4 kHz	0.1 kHz	
Operation (with sensing object approaching)	E1 models: Load ON E2 models: Load OFF								
Control output (switching capacity)	200 mA max.								
Circuit protection	Reverse connection protection, surge absorber, load short-circuit protection								
Indicator	Operation indicator (red LED)								
Ambient temperature (see note 2)	Operating: -40°C to 85°C (with no icing)								
Ambient humidity	Operating: 35% to 95%								
Temperature influence	±15% max. of sensing distance at 23°C in temperature range of -40°C to 85°C ±10% max. of sensing distance at 23°C in temperature range of -25°C to 70°C								
Voltage influence	±1% max. of sensing distance in rated voltage range ±15%								
Residual voltage	2.0 V max. (under load current of 200 mA with cable length of 2 m)								
Insulation resistance	50 MΩ min. (at 500 VDC) between current carry parts and case								
Dielectric strength	1,000 VAC for 1 min between current carry parts and case								
Vibration resistance	Destruction: 10 to 55 Hz, 1.5-mm double amplitude for 2 hrs each in X, Y, and Z directions								
Shock resistance	Destruction: 500 m/s <sup>2</sup> (approx. 50G) for 10 times each in X, Y, and Z directions		Destruction: 1,000 m/s <sup>2</sup> (approx. 50G) for 10 times each in X, Y, and Z directions 500 m/s <sup>2</sup> (approx. 50G) for E2E-X5M						
Degree of protection	IEC60529 IP67								
Weight	Pre-wired	Approx. 45 g		Approx. 120 g		Approx. 160 g		Approx. 270 g	
	Connector	---	Approx. 25 g			Approx. 45 g		Approx. 125 g	Approx. 124 g
Material	Case	Stainless steel		Brass					
	Sensing surface	PBT							

- Note:**
1. E2E models with an M18 or M30 connector operate at a non-smoothed, all-wave rectified, mean voltage range of 24 VDC ±20%.
  2. When using an E2E with an M8 connector at an ambient temperature range between 70°C and 85°C, supply 10 to 30 VDC to the E2E and make sure that the E2E has a control output of 100 mA maximum.

## E2E-C□C□/B□, E2E-X1C□/B□ DC 3-wire Models

Item	E2E-CR8C□/B□	E2E-X1C□/B□	E2E-C1C□/B□
Size	4 dia.	M5	5.4 dia.
Type	Shielded		
Sensing distance	0.8 mm ±10%	1 mm ±15%	
Supply voltage (operating voltage range)	12 to 24 VDC, ripple (p-p): 10% max., (10 to 30 VDC)		
Current consumption	17 mA max.		
Sensing object	Ferrous metal (refer to <i>Engineering Data</i> for non-ferrous metal)		
Setting distance	0 to 0.5 mm	0 to 0.7 mm	
Standard object (mild steel)	5 x 5 x 1 mm		
Differential travel	15% max. of sensing distance		
Response frequency	3 kHz		
Operation (with sensing object approaching)	C1/-B1 models: Load ON C2/-B2 models: Load OFF		
Control output (switching capacity)	100 mA max. at 30 VDC, open collector		
Circuit protection	Reverse connection protection, surge absorber		
Indicator	Sensing indicator (red LED)		
Ambient temperature	Operating: -25°C to 70°C (with no icing)		
Ambient humidity	Operating: 35% to 95%		
Temperature influence	±15% max. of sensing distance at 23°C in temperature range of -25°C to 70°C		
Voltage influence	±2.5% max. of sensing distance in rated voltage range ±15%		
Residual voltage	2.0 V max. (under load current of 100 mA with cable length of 2 m)		
Insulation resistance	50 MΩ min. (at 500 VDC) between current carry parts and case		
Dielectric strength	500 VAC for 1 min between current carry parts and case		
Vibration resistance	Destruction: 10 to 55 Hz, 1.5-mm double amplitude for 2 hrs each in X, Y, and Z directions		
Shock resistance	Destruction: 500 m/s <sup>2</sup> (approx. 50G) for 10 times each in X, Y, and Z directions		
Degree of protection	IEC60529 IP67		
Weight	Approx. 30 g		
Material	Case	Stainless steel	Brass
	Sensing surface	ABS	

## E2E-X□Y□ AC 2-wire Models

Item	E2E-X1R5Y□	E2E-X2MY□	E2E-X2Y□	E2E-X5MY□	E2E-X5Y□	E2E-X10MY□	E2E-X10Y□	E2E-X18MY□	
Size	M8		M12		M18		M30		
Type	Shielded	Unshielded	Shielded	Unshielded	Shielded	Unshielded	Shielded	Unshielded	
Sensing distance	1.5 mm ±10%	2 mm ±10%	2 mm ±10%	5 mm ±10%	5 mm ±10%	10 mm ±10%	10 mm ±10%	18 mm ±10%	
Supply voltage (operating voltage range) (see note 2)	24 to 240 VAC, 50/60 Hz (20 to 264 VAC)								
Current consumption	1.7 mA max.								
Sensing object	Ferrous metal (refer to <i>Engineering Data</i> for non-ferrous metal)								
Setting distance	0 to 1.2 mm	0 to 1.6 mm	0 to 1.6 mm	0 to 4.0 mm	0 to 4.0 mm	0 to 8.0 mm	0 to 8.0 mm	0 to 14.0 mm	
Standard object (mild steel)	8 x 8 x 1 mm	12 x 12 x 1 mm	12 x 12 x 1 mm	15 x 15 x 1 mm	18 x 18 x 1 mm	30 x 30 x 1 mm	30 x 30 x 1 mm	54 x 54 x 1 mm	
Differential travel	10% max. of sensing distance								
Response frequency	25 Hz								
Operation (with sensing object approaching)	Y1 models: Load ON Y2 models: Load OFF								
Control output (switching capacity)	5 to 100 mA max.		5 to 200 mA max.		5 to 300 mA max. (see note 1)				
Indicator	Operation indicator (red LED)								
Ambient temperature (see note 2)	Operating: -25°C to 70°C (with no icing)		Operating: -40°C to 85°C (with no icing) (see note 1)						
Ambient humidity	Operating: 35% to 95%								
Temperature influence	±15% max. of sensing distance at 23°C in temperature range of -40°C to 85°C ±10% max. of sensing distance at 23°C in temperature range of -25°C to 70°C								
Voltage influence	±1% max. of sensing distance in rated voltage range ±15%								
Residual voltage	Refer to <i>Engineering Data</i> .								
Insulation resistance	50 MΩ min. (at 500 VDC) between current carry parts and case								
Dielectric strength	4,000 VAC for 1 min between current carry parts and case (2,000 VAC for M8 types)								
Vibration resistance	Destruction: 10 to 55 Hz, 1.5-mm double amplitude for 2 hrs each in X, Y, and Z directions								
Shock resistance	Destruction: 500 m/s <sup>2</sup> (approx. 50G) for 10 times each in X, Y, and Z directions		Destruction: 1,000 m/s <sup>2</sup> (approx. 50G) for 10 times each in X, Y, and Z directions 500 m/s <sup>2</sup> (approx. 50G) for E2E-X5M						
Degree of protection	IEC60529 IP67								
Weight	Pre-wired	Approx. 45 g		Approx. 120 g		Approx. 160 g		Approx. 270 g	
	Connector	---	Approx. 25 g			Approx. 45 g		Approx. 125 g	Approx. 124 g
Material	Case	Stainless steel		Brass					
	Sensing surface	PBT							

- Note:**
1. When using an M18-or M30-sized E2E within an ambient temperature of 70°C to 85°C, make sure that the E2E has a control output of 200 mA maximum.
  2. When supplying 24 VAC to any of the above models, make sure that the operating ambient temperature range is over -25°C.

## AC/DC 2-wire Models

Item		E2E-X3T1	E2E-X7T1	E2E-X10T1
Size		M12	M18	M30
Type		Shielded		
Sensing distance		3 mm $\pm$ 10%	7 mm $\pm$ 10%	10 mm $\pm$ 10%
Supply voltage (operating voltage range)		24 to 240 VDC (20 to 264 VDC)/48 to 240 VAC (40 to 264 VAC)		
Current consumption		1.0 mA DC	2.0 mA DC	
Sensing object		Ferrous metal (refer to <i>Engineering Data</i> for non-ferrous metal)		
Setting distance		0 to 2.4 mm	0 to 5.6 mm	0 to 8.0 mm
Standard object (mild steel)		12 x 12 x 1 mm	18 x 18 x 1 mm	30 x 30 x 1 mm
Differential travel		10% max. of sensing distance		
Response frequency		1.0 kHz	0.5 kHz	0.4 kHz
Operation (with sensing object approaching)		Load ON		
Control output (switching capacity)		5 to 100 mA		
Circuit protection		Load short-circuit protection (at 20 to 40 VDC)		
Indicator		Operation indicator (red LED), operation set indicator (green LED)		
Ambient temperature		Operating: $-25^{\circ}\text{C}$ to $70^{\circ}\text{C}$ (with no icing)		
Ambient humidity		Operating: 35% to 95%		
Temperature influence		$\pm$ 10% max. of sensing distance at $23^{\circ}\text{C}$ in temperature range of $-25^{\circ}\text{C}$ to $70^{\circ}\text{C}$		
Voltage influence		$\pm$ 1% max. of sensing distance in rated voltage range $\pm$ 15%		
Residual voltage		6.0 VDC max. (under load current of 100 mA with cable length of 2 m) 10 VAC max. (under load current of 5 mA with cable length of 2 m)		
Insulation resistance		50 M $\Omega$ min. (at 500 VDC) between current carry parts and case		
Dielectric strength		4,000 VAC for 1 min between current carry parts and case		
Vibration resistance		Destruction: 10 to 55 Hz, 1.5-mm double amplitude for 2 hrs each in X, Y, and Z directions		
Shock resistance		Destruction: 1,000 m/s <sup>2</sup> (approx. 100G) for 10 times each in X, Y, and Z directions		
Degree of protection		IEC60529 IP67		
Weight		Approx. 55 g	Approx. 160 g	Approx. 220 g
Material	Case	Brass		
	Sensing surface	PBT		

## E2E2

## E2E2-X□D□ DC 2-wire Models

Item	E2E2-X3D□	E2E2-X8MD□	E2E2-X7D□	E2E2-X14MD□	E2E2-X10D□	E2E2-X20MD□
Size	M12		M18		M30	
Type	Shielded	Unshielded	Shielded	Unshielded	Shielded	Unshielded
Sensing distance	3 mm ±10%	8 mm ±10%	7 mm ±10%	14 mm ±10%	10 mm ±10%	20 mm ±10%
Supply voltage (operating voltage range)	12 to 24 VDC, ripple (p-p): 10% max., (10 to 30 VDC)					
Leakage current	0.8 mA max.					
Sensing object	Ferrous metal (refer to <i>Engineering Data</i> for non-ferrous metal)					
Setting distance	0 to 2.4 mm	0 to 6.4 mm	0 to 5.6 mm	0 to 11.2 mm	0 to 8.0 mm	0 to 16.0 mm
Standard object (mild steel)	12 x 12 x 1 mm	30 x 30 x 1 mm	18 x 18 x 1 mm	30 x 30 x 1 mm	30 x 30 x 1 mm	54 x 54 x 1 mm
Differential travel	10% max. of sensing distance					
Response frequency	1.0 kHz	0.8 kHz	0.5 kHz	0.4 kHz	0.4 kHz	0.1 kHz
Operation (with sensing object approaching)	D1 models: Load ON D2 models: Load OFF					
Control output (switching capacity)	3 to 100 mA					
Circuit protection	Surge absorber, load short-circuit protection					
Indicator	D1 models: Operation indicator (red LED), operation set indicator (green LED) D2 models: Operation indicator (red LED)					
Ambient temperature	Operating: -25°C to 70°C (with no icing)					
Ambient humidity	Operating: 35% to 95%					
Temperature influence	±10% max. of sensing distance at 23°C in temperature range of -25°C to 70°C					
Voltage influence	±1% max. of sensing distance in rated voltage range ±15%					
Residual voltage	3.0 V max. (under load current of 100 mA with cable length of 2 m)					
Insulation resistance	50 MΩ min. (at 500 VDC) between current carry parts and case					
Dielectric strength	1,000 VAC for 1 min between current carry parts and case					
Vibration resistance	Destruction: 10 to 55 Hz, 1.5-mm double amplitude for 10 times each in X, Y, and Z directions					
Shock resistance	Destruction: 1,000 m/s <sup>2</sup> (approx. 100G) for 10 times each in X, Y, and Z directions					
Degree of protection	IEC60529 IP67					
Weight	65 g		150 g		220 g	
Material	Case	Brass				
	Sensing surface	PBT				

## E2E2-X□C□/B□ DC 3-wire Models

Item	E2E2-X2C□/ B□	E2E2-X5MC□/ B□	E2E2-X5C□/ B□	E2E2-X10MC□/ B□	E2E2-X10C□/ B□	E2E2-X18MC□/ B□
Size	M12		M18		M30	
Type	Shielded	Unshielded	Shielded	Unshielded	Shielded	Unshielded
Sensing distance	2 mm ±10%	5 mm ±10%	5 mm ±10%	10 mm ±10%	10 mm ±10%	18 mm ±10%
Supply voltage (operating voltage range)	12 to 24 VDC, ripple (p-p): 10% max., (10 to 55 VDC)					
Current consumption	13 mA max.					
Sensing object	Ferrous metal (refer to <i>Engineering Data</i> for non-ferrous metal)					
Setting distance	0 to 1.6 mm	0 to 4.0 mm	0 to 4.0 mm	0 to 8.0 mm	0 to 8.0 mm	0 to 14.0 mm
Standard object (mild steel)	12 x 12 x 1 mm	15 x 15 x 1 mm	18 x 18 x 1 mm	30 x 30 x 1 mm	30 x 30 x 1 mm	54 x 54 x 1 mm
Differential travel	10% max. of sensing distance					
Response frequency	1.5 kHz	0.4 kHz	0.6 kHz	0.2 kHz	0.4 kHz	0.1 kHz
Operation (with sensing object approaching)	B1/C1 models: Load ON B2/C2 models: Load OFF					
Control output (switching capacity)	200 mA max., open collector					
Circuit protection	Reverse connection protection, surge absorber, load short-circuit protection					
Indicator	Operation indicator (red LED)					
Ambient temperature	Operating: -40°C to 85°C (with no icing)					
Ambient humidity	Operating: 35% to 95%					
Temperature influence	±15% max. of sensing distance at 23°C in temperature range of -40°C to 85°C ±10% max. of sensing distance at 23°C in temperature range of -25°C to 70°C					
Voltage influence	±1% max. of sensing distance in rated voltage range ±15%					
Residual voltage	2.0 V max. (under load current of 200 mA with cable length of 2 m)					
Insulation resistance	50 MΩ min. (at 500 VDC) between current carry parts and case					
Dielectric strength	1,000 VAC for 1 min between current carry parts and case					
Vibration resistance	Destruction: 10 to 55 Hz, 1.5-mm double amplitude for 10 times each in X, Y, and Z directions					
Shock resistance	Destruction: 1,000 m/s <sup>2</sup> (approx. 100G) for 10 times each in X, Y, and Z directions					
Degree of protection	IEC60529 IP67					
Weight	65 g		150 g		220 g	
Material	Case	Brass				
	Sensing surface	PBT				

## E2E2-X□Y□ AC 2-wire Models

Item	E2E2-X2Y□	E2E2-X5MY□	E2E2-X5Y□	E2E2-X10MY□	E2E2-X10Y□	E2E2-X18MY□
Size	M12		M18		M30	
Type	Shielded	Unshielded	Shielded	Unshielded	Shielded	Unshielded
Sensing distance	2 mm ±10%	5 mm ±10%	5 mm ±10%	10 mm ±10%	10 mm ±10%	18 mm ±10%
Supply voltage (operating voltage range) (see note 2)	24 to 240 VAC, 50/60 Hz (20 to 264 VAC)					
Leakage current	1.7 mA max.					
Sensing object	Ferrous metal					
Setting distance	0 to 1.6 mm	0 to 4.0 mm	0 to 4.0 mm	0 to 8.0 mm	0 to 8.0 mm	0 to 14.0 mm
Standard object (mild steel)	12 x 12 x 1 mm	15 x 15 x 1 mm	18 x 18 x 1 mm	30 x 30 x 1 mm	30 x 30 x 1 mm	54 x 54 x 1 mm
Differential travel	10% max. of sensing distance					
Response frequency	25 Hz					
Operation (with sensing object approaching)	Y1 models: Load ON Y2 models: Load OFF					
Control output (switching capacity)	5 to 200 mA		5 to 300 mA (see note 1)			
Indicator	Operation indicator (red LED)					
Ambient temperature	Operating: -40°C to 85°C (with no icing) (see notes 1 and 2)					
Ambient humidity	Operating: 35% to 95%					
Temperature influence	±15% max. of sensing distance at 23°C in temperature range of -40°C to 85°C ±10% max. of sensing distance at 23°C in temperature range of -25°C to 70°C					
Voltage influence	±1% max. of sensing distance in rated voltage range ±15%					
Residual voltage	Refer to <i>Engineering Data</i> .					
Insulation resistance	50 MΩ min. (at 500 VDC) between current carry parts and case					
Dielectric strength	4,000 VAC for 1 min between current carry parts and case					
Vibration resistance	Destruction: 10 to 55 Hz, 1.5-mm double amplitude for 10 times each in X, Y, and Z directions					
Shock resistance	Destruction: 1,000 m/s <sup>2</sup> (approx. 100G) for 10 times each in X, Y, and Z directions					
Degree of protection	IEC60529 IP67					
Weight	65 g		150 g		220 g	
Material	Case	Brass				
	Sensing surface	PBT				

- Note:**
- When using an M18-or M30-sized E2E2 within an ambient temperature of 70°C to 85°C, make sure that the E2E2 has a control output of 200 mA maximum.
  - When supplying 24 VAC to any of the above models, make sure that the operating ambient temperature range is over -25°C.

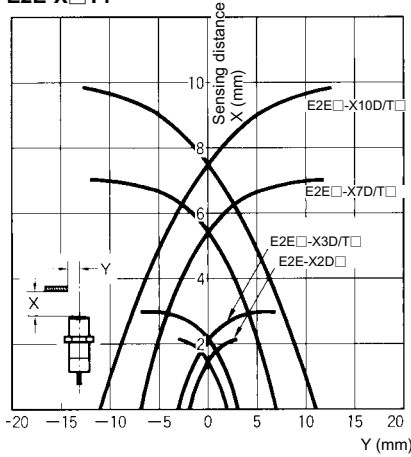
# Engineering Data

## E2E

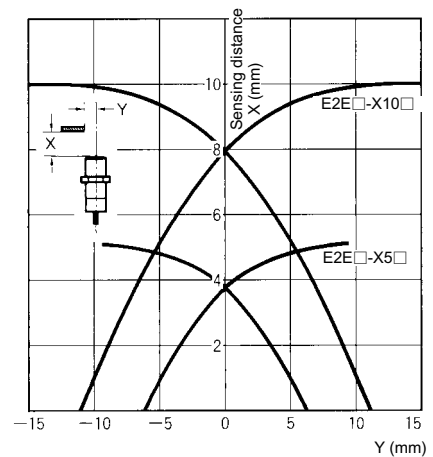
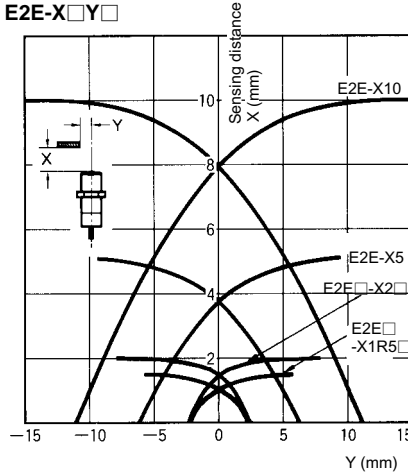
### Operating Range (Typical)

#### Shielded Models

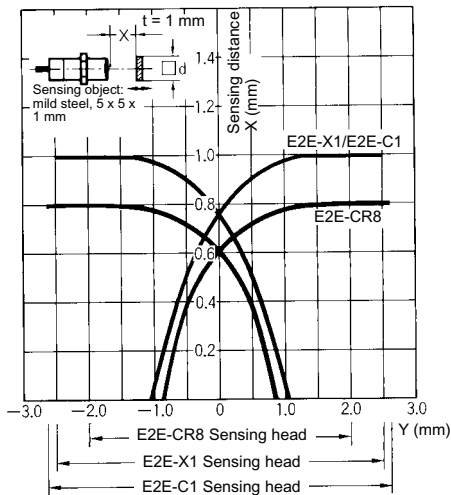
E2E-X□D□  
E2E-X□T1



E2E-X□E□/F□  
E2E-X□Y□

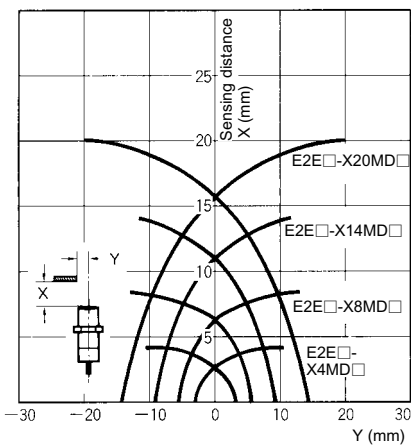


E2E-C□C□/B□  
E2E-X□C□/B□

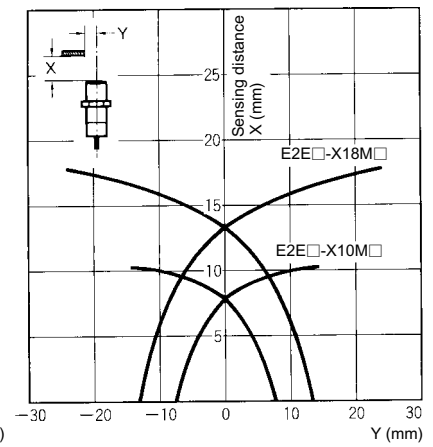
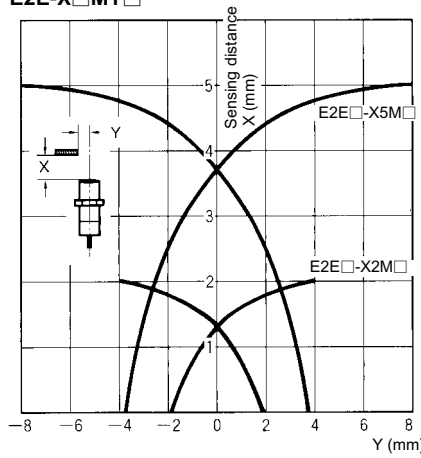


#### Unshielded Models

E2E-X□MD□



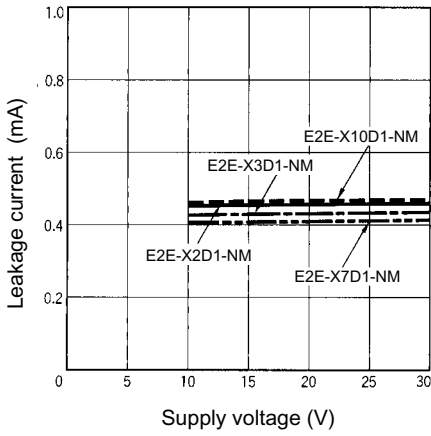
E2E-X□ME□/F□  
E2E-X□MY□



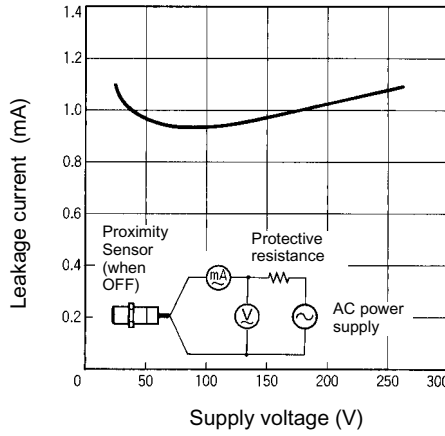


**Leakage Current (Typical)**

**E2E-X□D□**

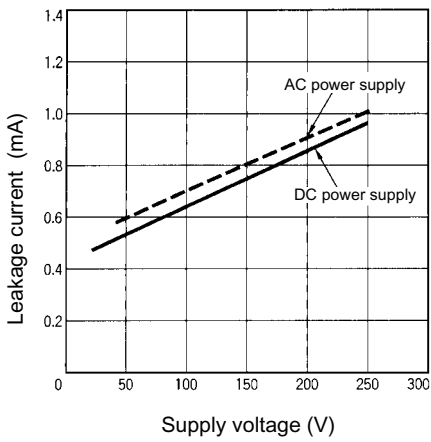


**E2E-X□Y□**



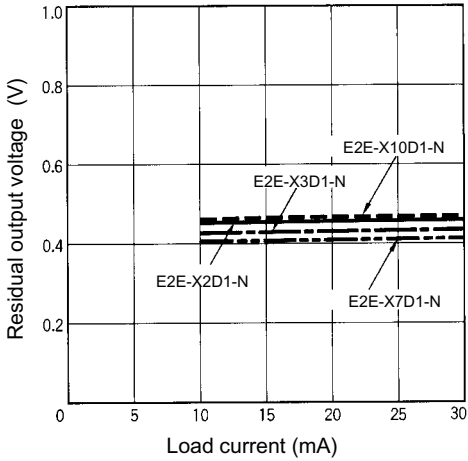
**E2E-X□T1**

**DC/AC**

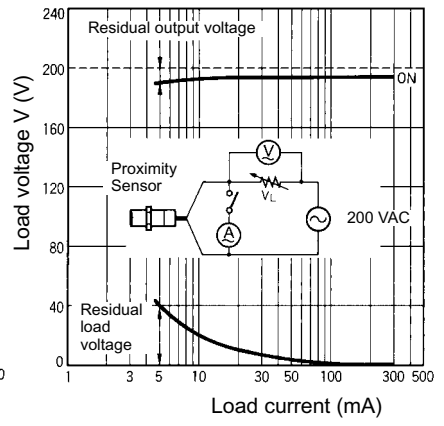
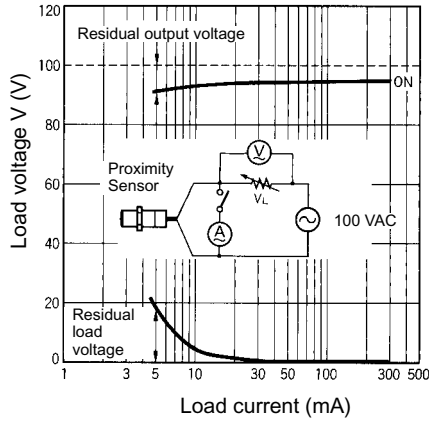
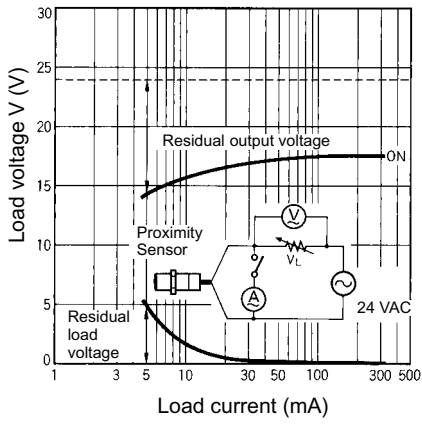


**Residual Output Voltage (Typical)**

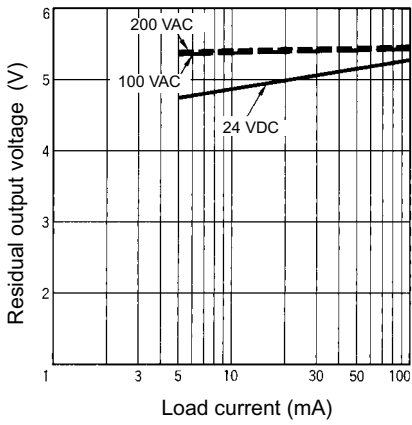
**E2E-X□D□**



E2E-X□Y□

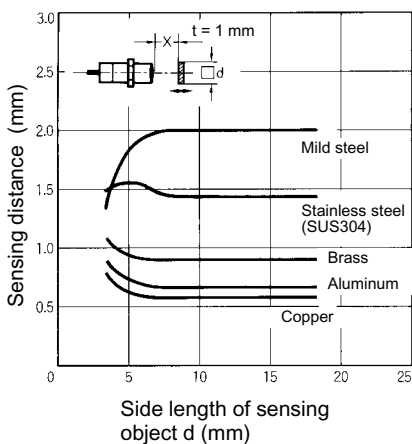


E2E-X□T1

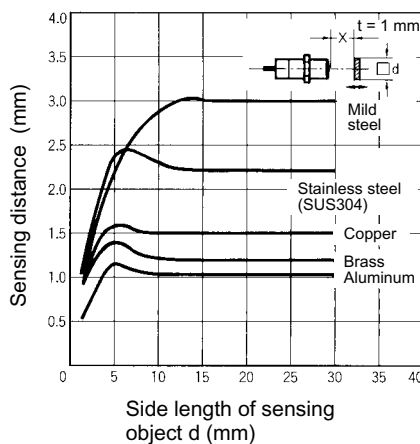


Sensing Distance vs. Sensing Object (Typical)

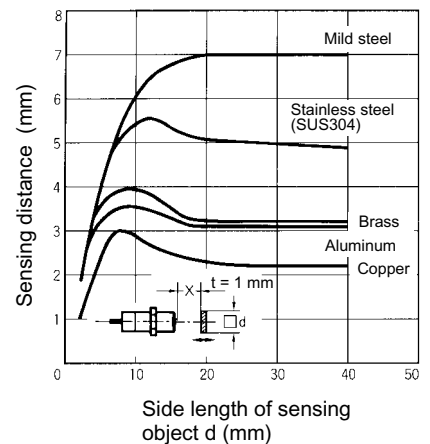
E2E-X2D



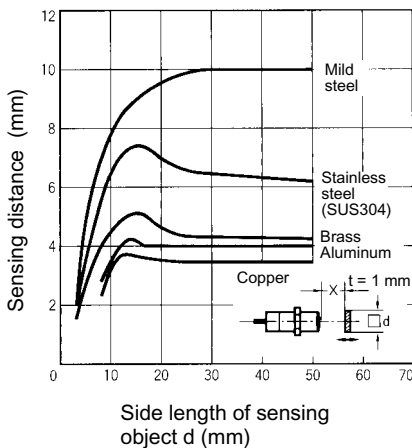
E2E-X3D  
E2E-X3T1



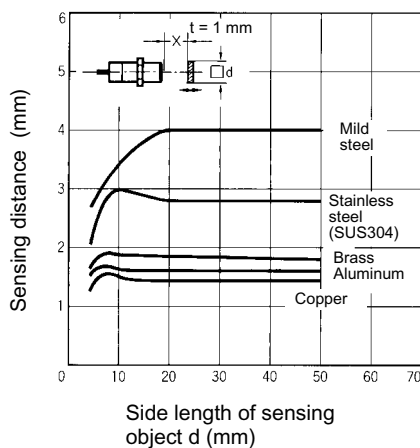
E2E-X7D  
E2E-X7T1



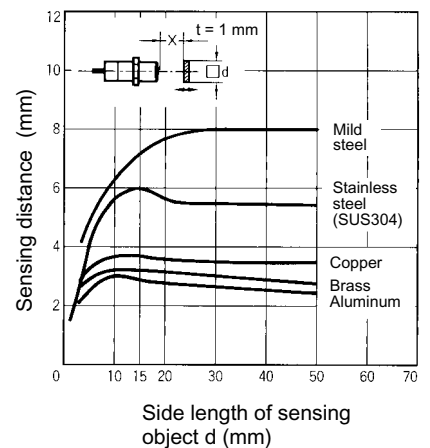
E2E-X10D  
E2E-X10T1



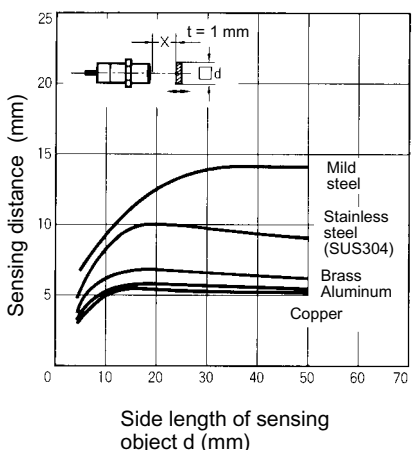
E2E-X4MD



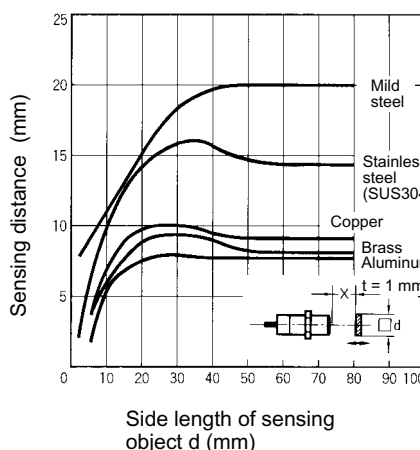
E2E-X8MD



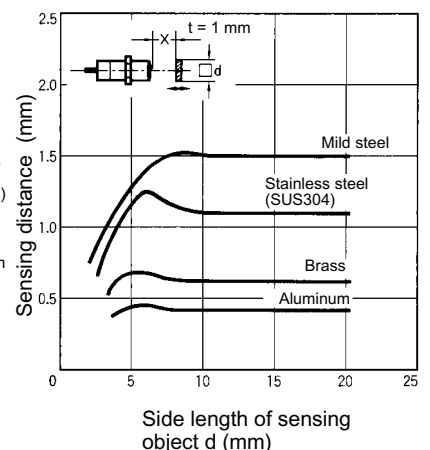
E2E-X14MD



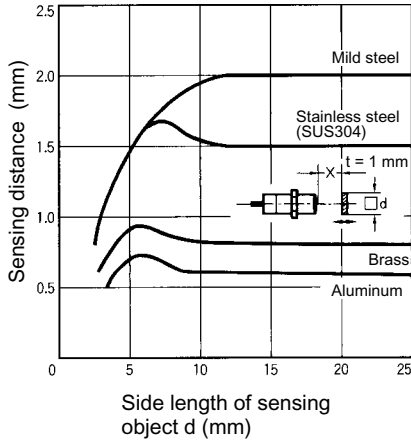
E2E-X20MD



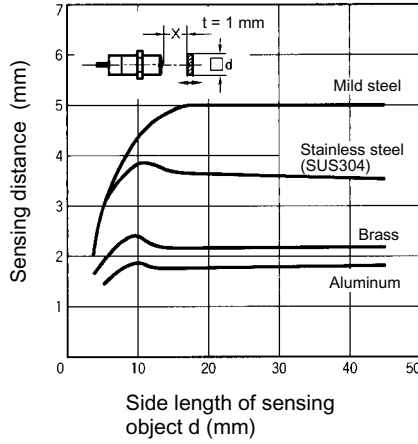
E2E-X1R5E/F  
E2E-X1R5Y



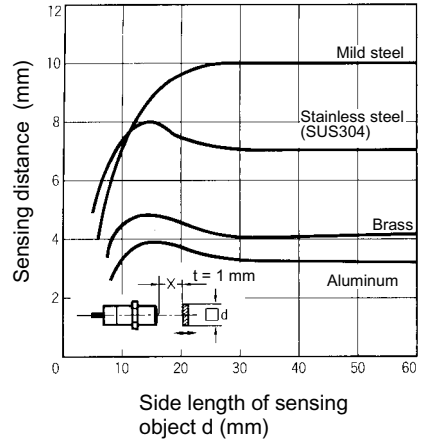
E2E-X2E□/F□  
E2E-X2Y□



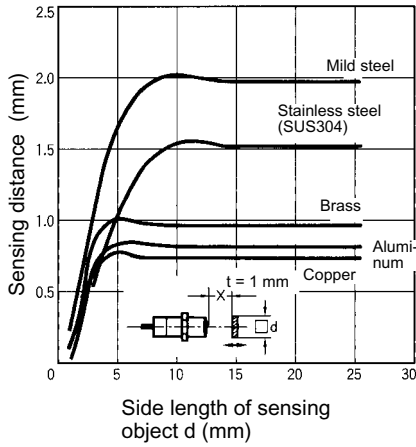
E2E-X5E□/F□  
E2E-X5Y□



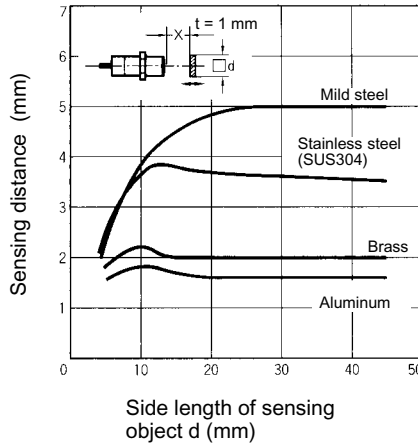
E2E-X10E□/F□  
E2E-X10Y□



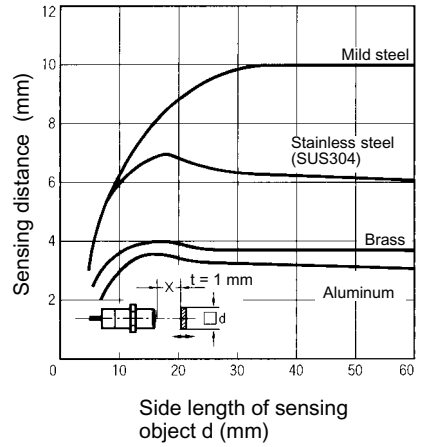
E2E-X2ME□/F□  
E2E-X2MY□



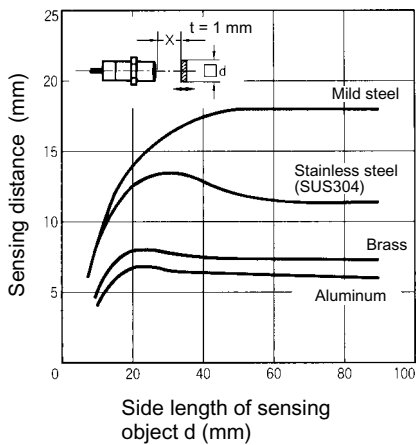
E2E-X5ME□/F□  
E2E-X5MY□



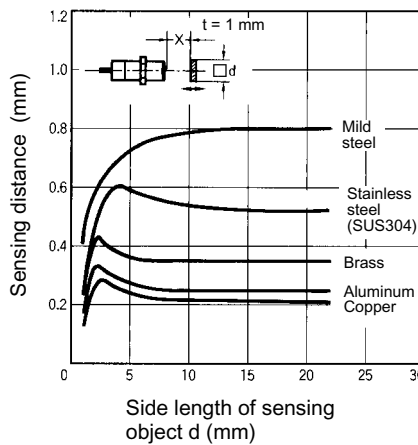
E2E-X10ME□/F□  
E2E-X10MY□



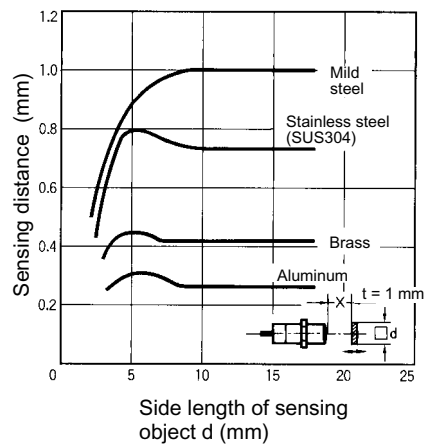
E2E-X18ME□/F□  
E2E-X18MY□



E2E-CR8□□



E2E-X1□□  
E2E-C1□□

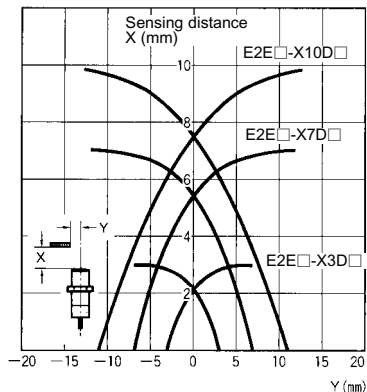


**E2E2**

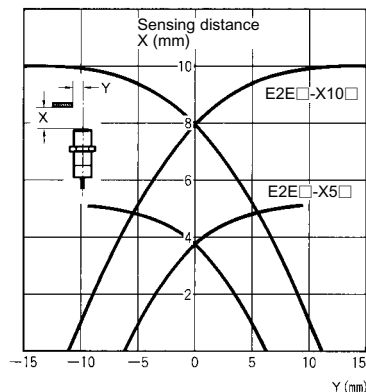
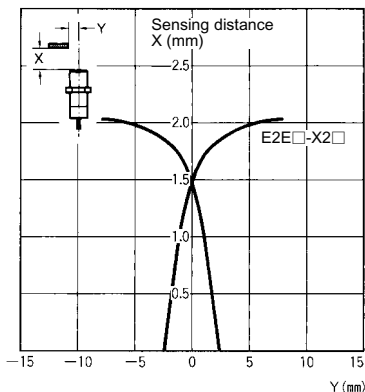
**Operating Range (Typical)**

**Shielded Models**

E2E2-X□D□

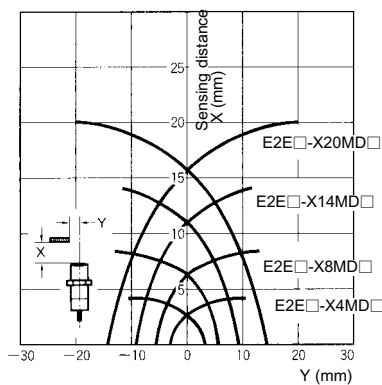


E2E2-X□C□/B□  
E2E2-X□Y□

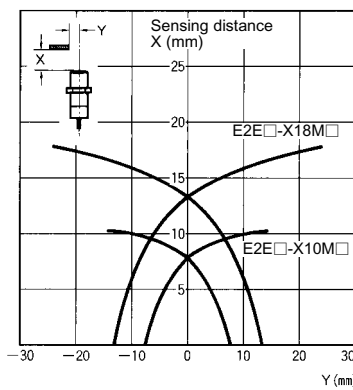
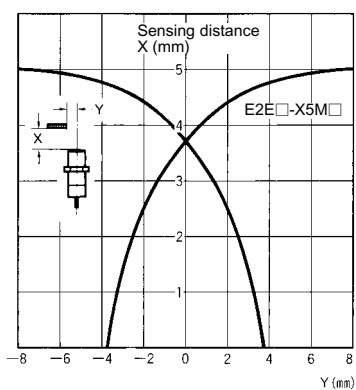


**Unshielded Models**

E2E2-X□MD□

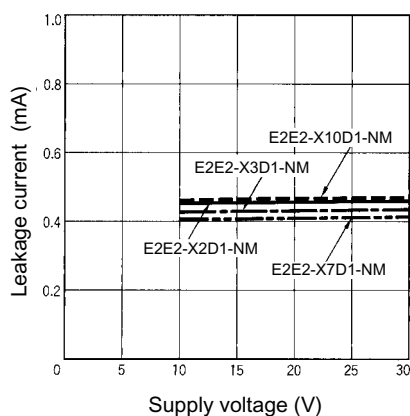


E2E2-X□MC□/B□  
E2E2-X□MY□

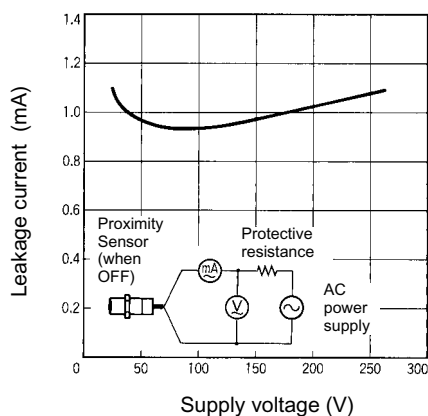


**Leakage Current (Typical)**

E2E2-X□D□

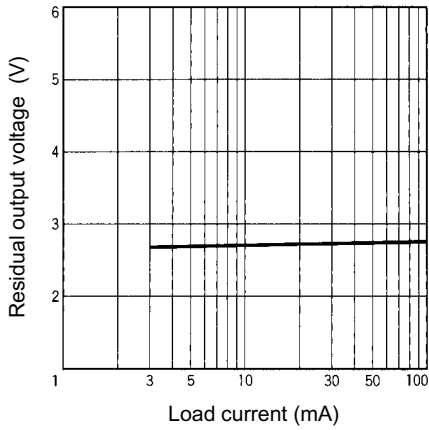


E2E2-X□Y□

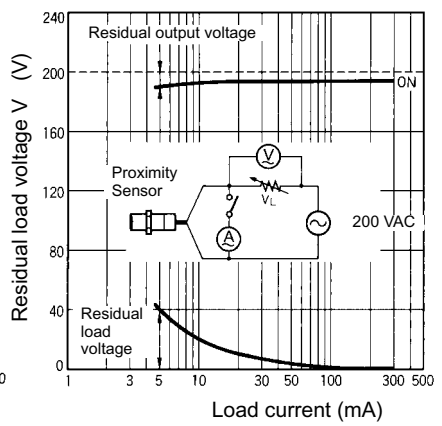
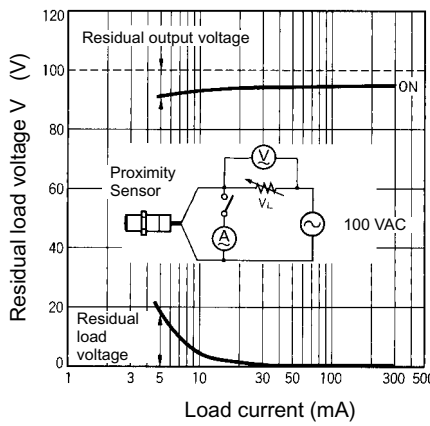
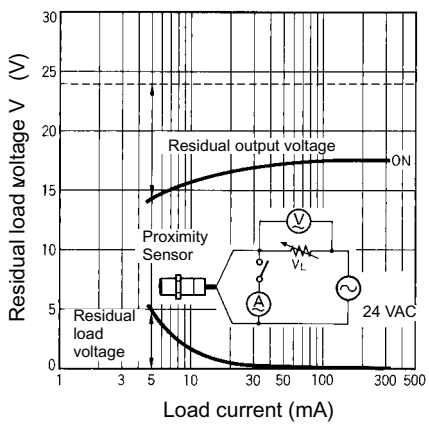


**Residual Output Voltage (Typical)**

E2E2-X□D□

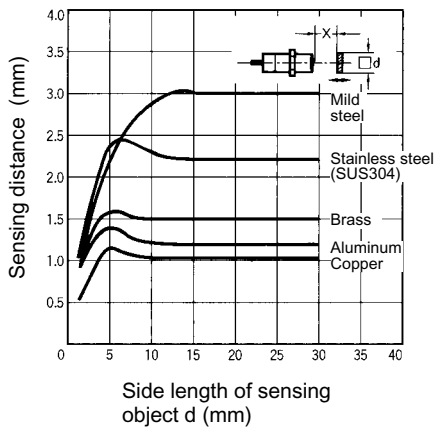


E2E2-X□Y□

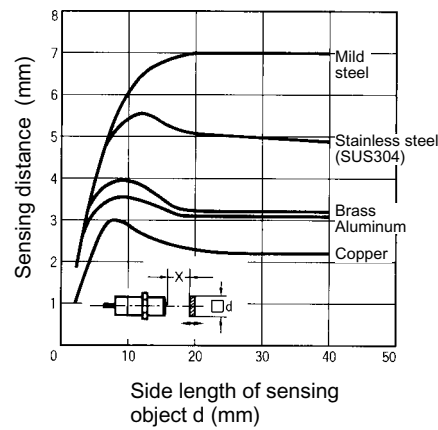


**Sensing Distance vs. Sensing Object (Typical)**

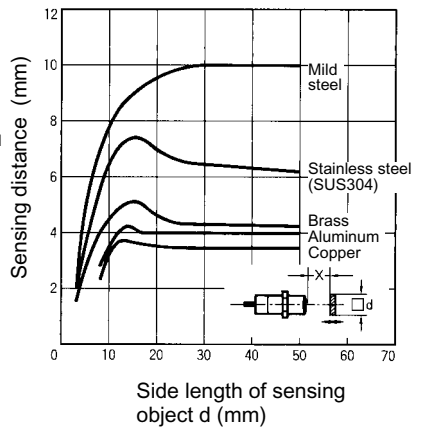
E2E2-X3D□



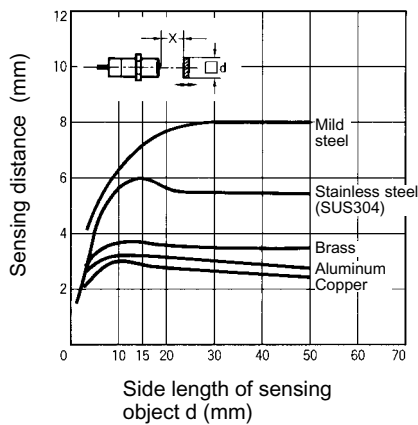
E2E2-X7D□



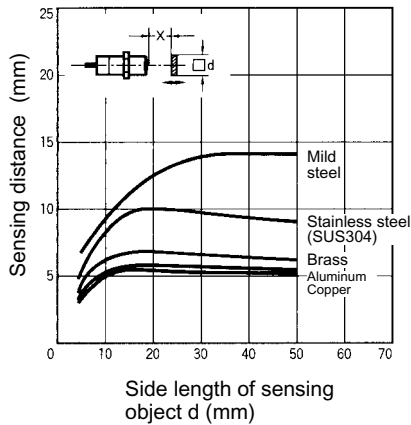
E2E2-X10D□



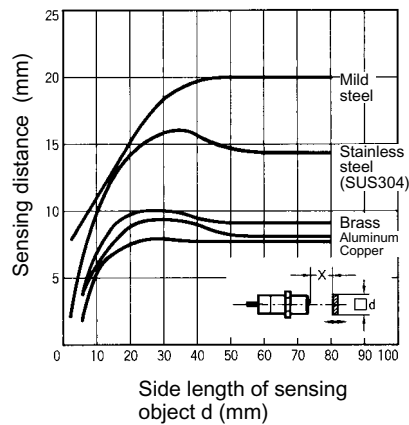
**E2E2-X8MD**



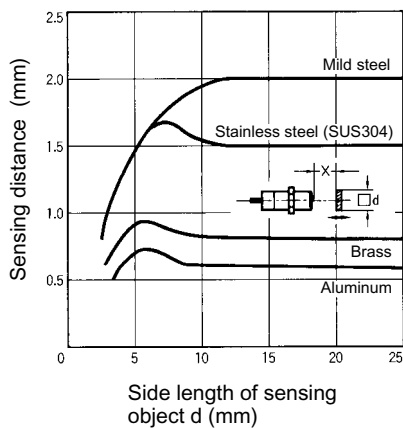
**E2E2-X14MD**



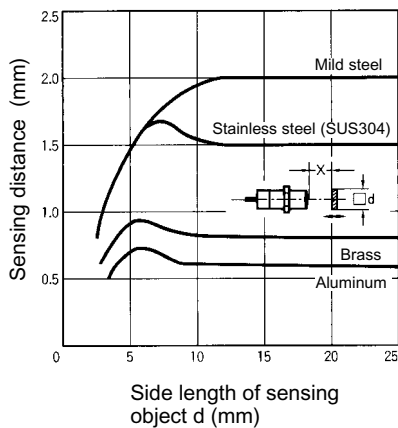
**E2E2-X20MD**



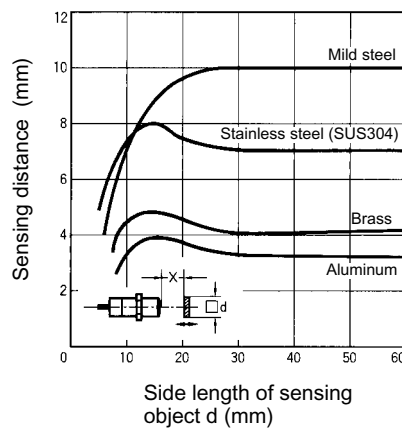
**E2E2-X2C/B**  
**E2E2-X2Y**



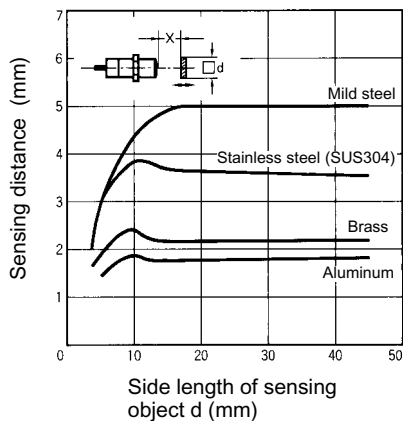
**E2E2-X5C/B**  
**E2E2-X5Y**



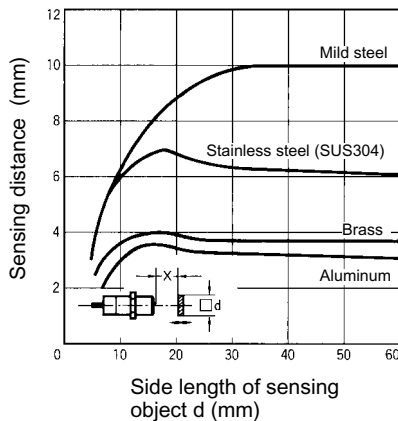
**E2E2-X10C/B**  
**E2E2-X10Y**



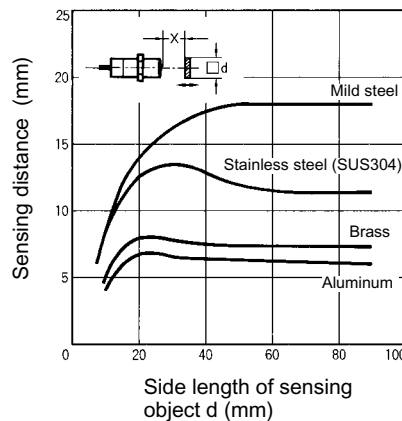
**E2E2-X5MC/B**  
**E2E2-X5MY**



**E2E2-X10MC/B**  
**E2E2-X10MY**



**E2E2-X18MC/B**  
**E2E2-X18MY**



# Operation

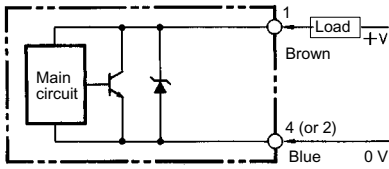
## Output Circuits

### E2E

#### E2E-X□D□ DC 2-wire Models

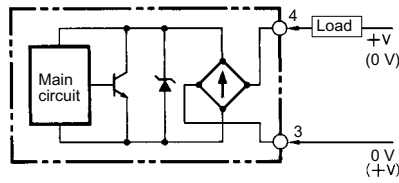
##### E2E-X□D□

Without Diagnostic Output



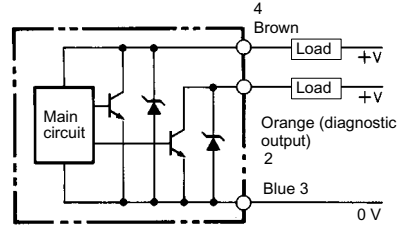
##### E2E-X□D1-M1J-T

No Polarity



##### E2E-X□D1S

With Diagnostic Output

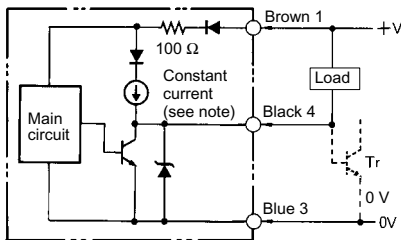


- Note:**
1. The load can be connected to either the +V or 0-V side.
  2. The E2E-X□D1-M1J-T has no polarity. Therefore, terminals 3 and 4 have no polarity.

#### DC 3-wire Models

##### E2E-X□E□

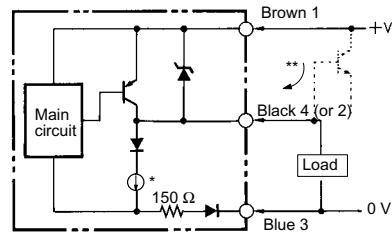
NPN Output



**Note:** Constant current output is 1.5 to 3 mA.

##### E2E-X□F□

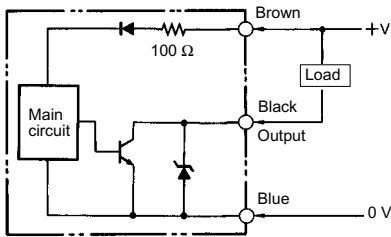
PNP Output



- \* Constant current output is 1.5 to 3 mA.
- \*\* When connecting to a Tr circuit.

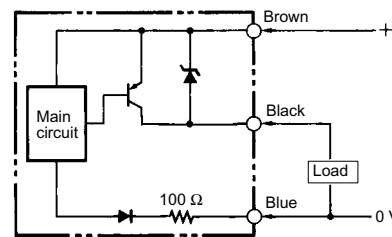
##### E2E-C/X□C□

NPN Open Collector Output

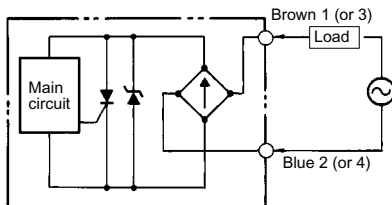


##### E2E-C/X□B□

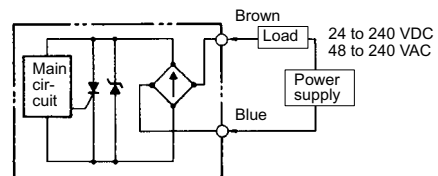
PNP Open Collector Output



#### E2E-X□Y□ AC 2-wire Models



#### E2E-X□T1 AC/DC 2-wire Models

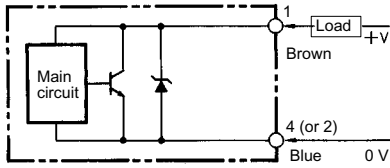


**Note:** The load can be connected as shown above regardless of the polarity of the E2E. There is no need to be concerned about the polarity (Brown/Blue) of the Proximity Sensor.

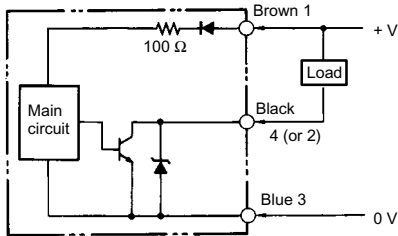


**E2E2**

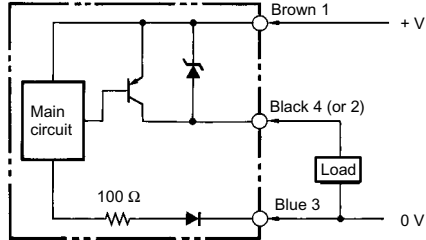
**E2E2-X□D□ DC 2-wire Models**



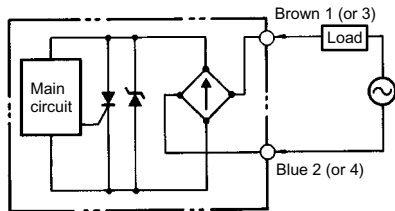
**E2E2-X□C□ DC 3-wire Models**



**E2E2-X□B□ DC 3-wire Models**



**E2E2-X□Y□ DC 2-wire Models**



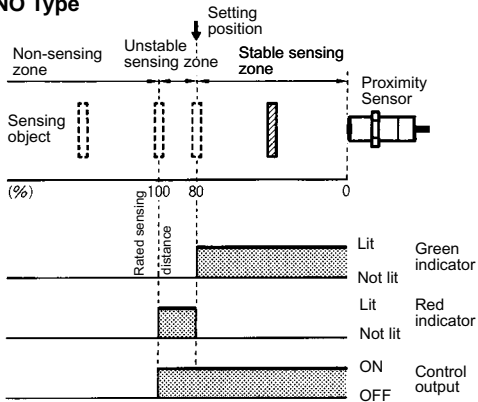
■ Operating Chart

E2E

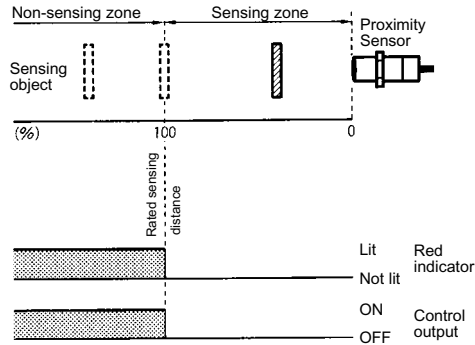
E2E-X□D□ DC 2-wire Models  
E2E-X□T1 AC/DC 2-wire Models

E2E-X□D1  
E2E-X□T1

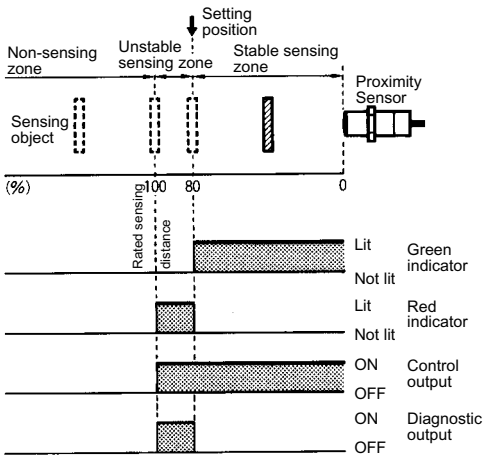
NO Type



E2E-X□D2  
NC Type



E2E-X□D1S

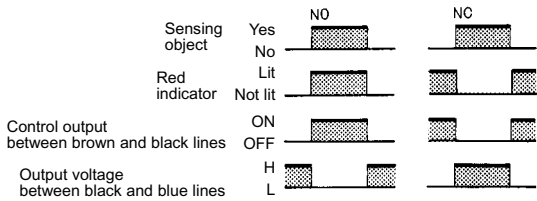


**Note:** The diagnostic output of the E2E-X□D1S is ON when there is a coil burnout or the sensing object is located in the unstable sensing range for 0.3 s or more.

DC 3-wire Models

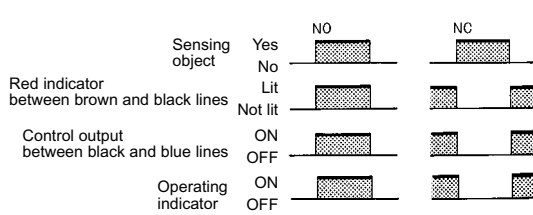
E2E-X□E□

NPN Output



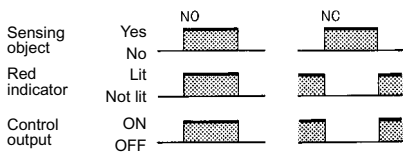
E2E-X□F□

PNP Output



E2E-C/X□C□/B□

NPN/PNP Open Collector Output



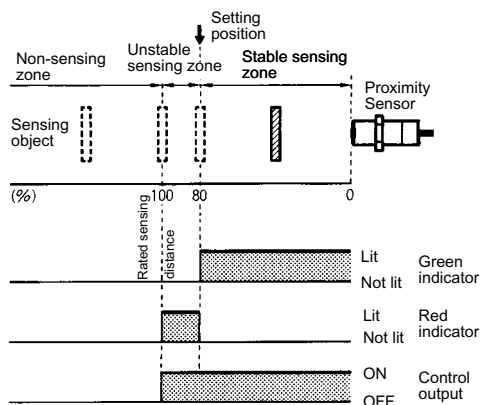
**E2E-X□Y□ AC 2-wire Models**

Sensing object	Yes	NO	NC
	No	Not lit	Lit
Red indicator	Lit	ON	OFF
	Not lit	OFF	ON
Control output	ON	ON	OFF
	OFF	OFF	ON

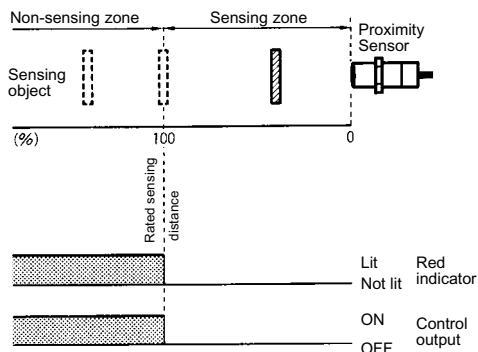
**E2E2**

**E2E2-X□D□ DC 2-wire Models**

**NO Type**



**NC Type**



**E2E2-X□C□/B□ DC 3-wire Models**

**NPN/PNP Open Collector Output**

Sensing object	Yes	NO	NC
	No	Not lit	Lit
Control output	ON	ON	OFF
	OFF	OFF	ON
Red indicator	Lit	ON	OFF
	Not lit	OFF	ON

**E2E2-X□Y□ AC 2-wire Models**

Sensing object	Yes	NO	NC
	No	Not lit	Lit
Control output	ON	ON	OFF
	OFF	OFF	ON
Red indicator	Lit	ON	OFF
	Not lit	OFF	ON

# Dimensions

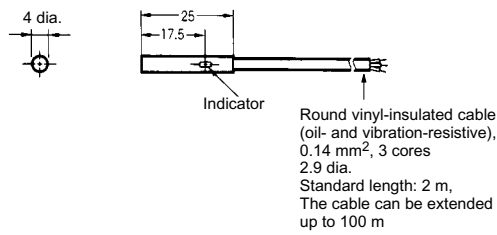
Note: All units are in millimeters unless otherwise indicated.

## E2E

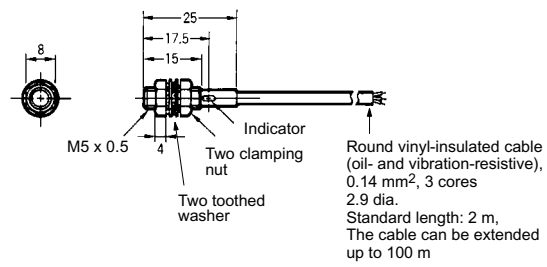
Type			DC 2-wire		DC 3-wire		AC 2-wire		AC/DC 2-wire		
			Part number	Figure no.	Part number	Figure no.	Part number	Figure no.	Part number	Figure no.	
Pre-wired	Shielded	4 dia.	---	---	E2E-CR8□□	1	---	---	---	---	
		M5	---	---	E2E-X1□□	3	---	---	---	---	
		5.4 dia.	---	---	E2E-C1□□	2	---	---	---	---	
		M8	E2E-X2D□-N	4	E2E-X1R5E□/F□	4	E2E-X1R5Y□	6	---	---	
		M12	E2E-X3D□-N	8	E2E-X2E□/F□	8	E2E-X2Y□	10	E2E-X3T1	12	
		M18	E2E-X7D□-N	13	E2E-X5E□/F□	13	E2E-X5Y□	13	E2E-X7T1	13	
	M30	E2E-X10D□-N	15	E2E-X10E□/F□	15	E2E-X10Y12	15	E2E-X10T1	15		
	Un-shielded	M8	E2E-X4MD□	5	E2E-X2ME□/F□	5	E2E-X2MY□	7	---	---	
		M12	E2E-X8MD□	9	E2E-X5ME□/F□	9	E2E-X5MY□	11	---	---	
		M18	E2E-X14MD□	14	E2E-X10ME□/F□	14	E2E-X10MY□	14	---	---	
M30		E2E-X20MD□	16	E2E-X18ME□/F□	16	E2E-X18MY□	16	---	---		
Connector (M12)	Shielded	M8	E2E-X2D□-M1G	17	E2E-X1R5E□-M1 /F□-M1	17	---	---	---	---	
		M12	E2E-X3D□-M1G	19	E2E-X2E□-M1 /F□-M1	19	E2E-X2Y1-M1	21	---	---	
		M18	E2E-X7D□-M1G	23	E2E-X5E□-M1 /F□-M1	23	E2E-X5Y1-M1	23	---	---	
		M30	E2E-X10D□-M1G	25	E2E-X10E□-M1 /F□-M1	25	E2E-X10Y1-M1	25	---	---	
	Un-shielded	M8	E2E-X4MD□-M1G	18	E2E-X2ME□-M1 /F□-M1	18	---	---	---	---	
		M12	E2E-X8MD□-M1G	20	E2E-X5ME□-M1 /F□-M1	20	E2E-X5MY□-M1	22	---	---	
		M18	E2E-X14MD□-M1G	24	E2E-X10ME□-M1 /F□-M1	24	E2E-X10MY□-M1	24	---	---	
		M30	E2E-X20MD□-M1G	26	E2E-X18ME□-M1 /F□-M1	26	E2E-X18MY□-M1	26	---	---	
	Connector (M8)	Shielded	M8	E2E-X2D□-M3G	27	E2E-X1R5E□-M3 /F□-M3	27	---	---	---	---
		Un-shielded		E2E-X4MD□-M3G	28	E2E-X2ME□-M3 /F□-M3	28	---	---	---	---
Connector extension	Shielded	M12	E2E-X3D1-M1GJ	29	---	---	---	---	---	---	
		M18	E2E-X7D1-M1GJ	31	---	---	---	---	---	---	
		M30	E2E-X10D1-M1GJ	33	---	---	---	---	---	---	
	Un-shielded	M12	E2E-X8MD1-M1GJ	30	---	---	---	---	---	---	
		M18	E2E-X14MD1-M1GJ	32	---	---	---	---	---	---	
	M30	E2E-X20MD1-M1GJ	34	---	---	---	---	---	---		
Connector extension (no polarity)	Shielded	M12	E2E-X3D1-M1J-T	29	---	---	---	---	---	---	
		M18	E2E-X7D1-M1J-T	31	---	---	---	---	---	---	
		M30	E2E-X10D1-M1J-T	33	---	---	---	---	---	---	

**Pre-wired Models (Shielded)**

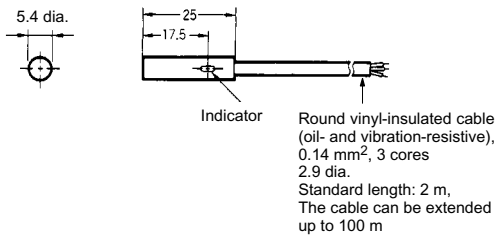
**Fig. 1 : E2E-CR8□□**



**Fig. 2 : E2E-X1□□**

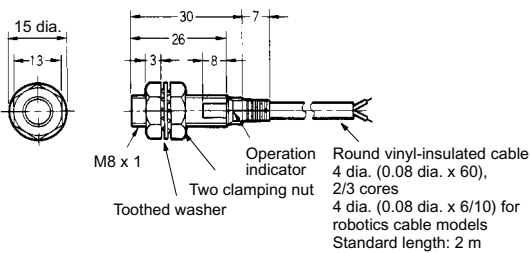


**Fig. 3 : E2E-C1□□**



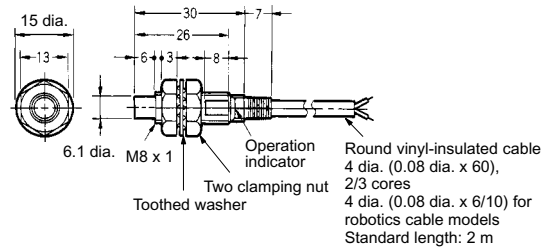
**Pre-wired Models (Shielded)**

**Fig. 4 : E2E-X2D□-N  
E2E-X1R5E□/F□**

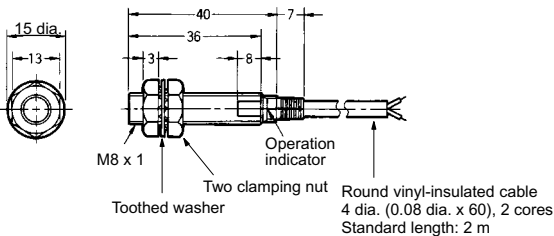


**Pre-wired Models (Unshielded)**

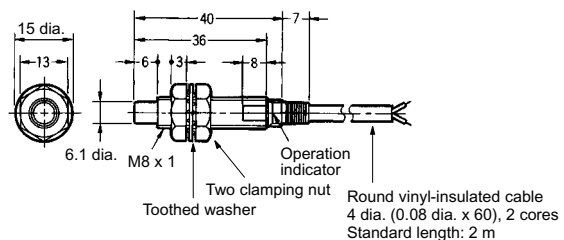
**Fig. 5 : E2E-X4MD□  
E2E-X2ME□/F□**



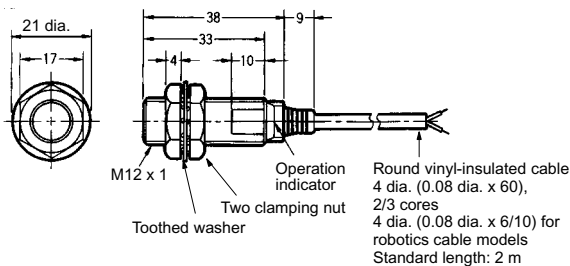
**Fig. 6 : E2E-X1R5Y□**



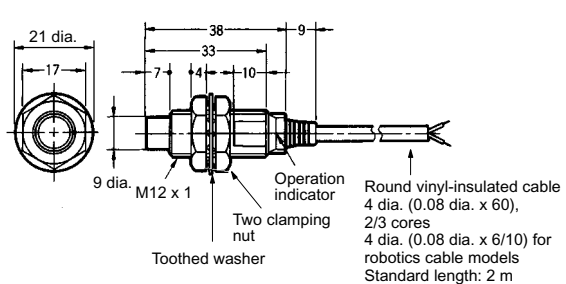
**Fig. 7 : E2E-X2MY□**



**Fig. 8 : E2E-X3D□-N  
E2E-X2E□/F□**

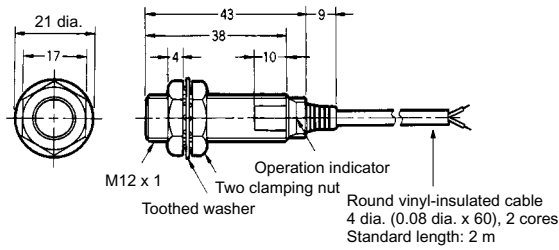


**Fig. 9 : E2E-X8MD□  
E2E-X5ME□/F□**



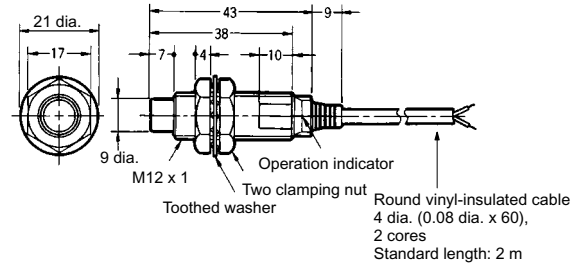
**Pre-wired Models  
(Shielded)**

**Fig. 10 : E2E-X2Y□**

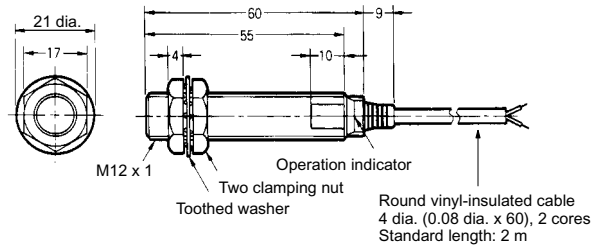


**Pre-wired Models  
(Unshielded)**

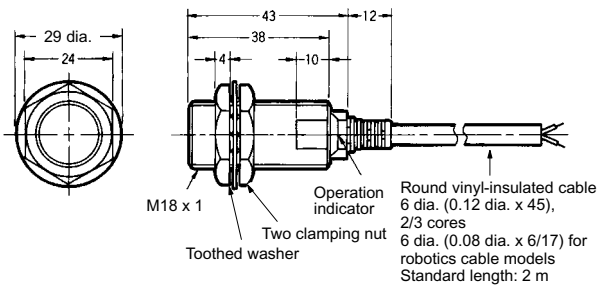
**Fig. 11 : E2E-X5MY□**



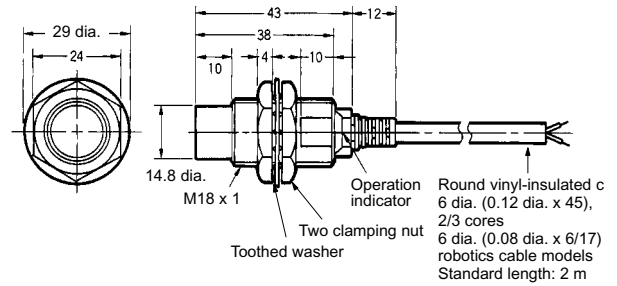
**Fig. 12 : E2E-X3T1**



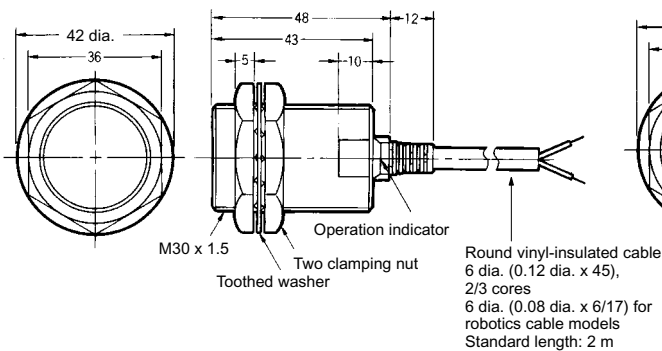
**Fig. 13 : E2E-X7D□-N/E2E-X5E□/F□  
E2E-X5Y□/E2E-X7T1**



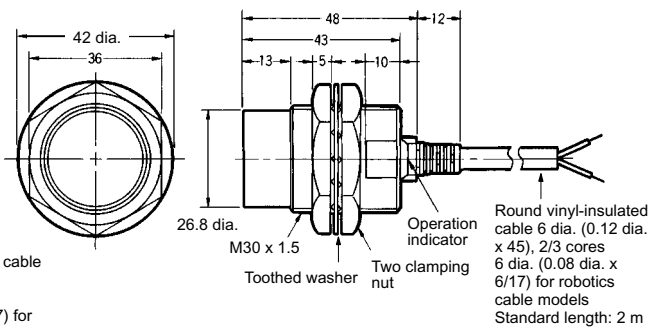
**Fig. 14 : E2E-X14MD□/E2E-X10ME□/F□  
E2E-X10MY□**



**Fig. 15 : E2E-X10D□-N/E2E-X10E□/F□  
E2E-X10Y□/E2E-X10T1**

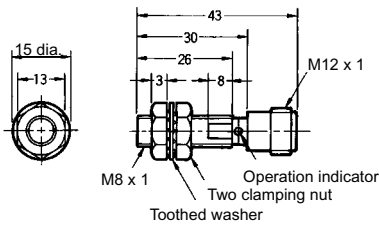


**Fig. 16 : E2E-X20MD□/E2E-X18ME□/F□  
E2E-X18MY□**

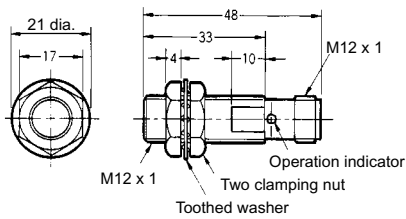


**Connector Models  
(Shielded)**

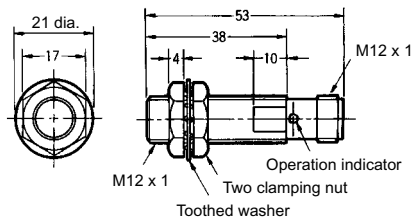
**Fig. 17 : E2E-X2D□-M1G  
E2E-X1R5E□-M1/F□-M1**



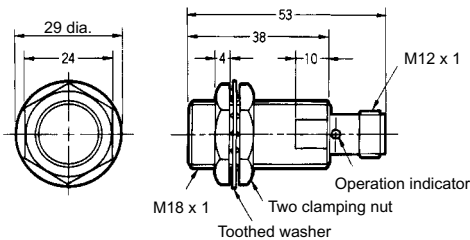
**Fig. 19 : E2E-X3D□-M1G  
E2E-X2E□-M1/F□-M1**



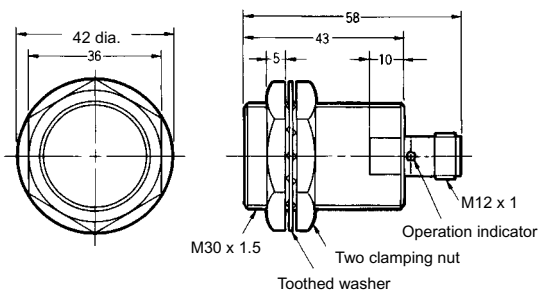
**Fig. 21 : E2E-X2Y1-M1**



**Fig. 23 : E2E-X7D□-M1G/E2E-X5E□-M1/F□-M1  
E2E-X5Y1-M1**

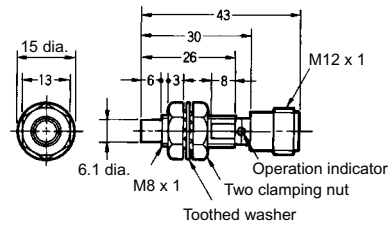


**Fig. 25 : E2E-X10D□-M1G/E2E-X10E□-M1/F□-M1  
E2E-X10Y1-M1**

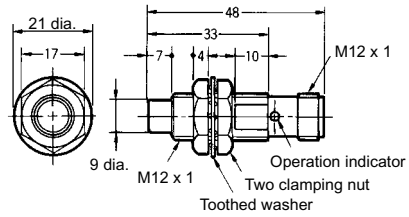


**Connector Models  
(Unshielded)**

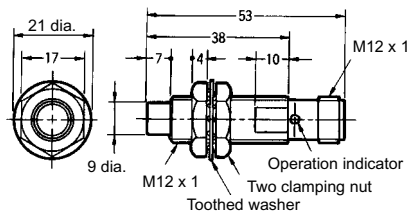
**Fig. 18 : E2E-X4MD□-M1G  
E2E-X2ME□-M1/F□-M1**



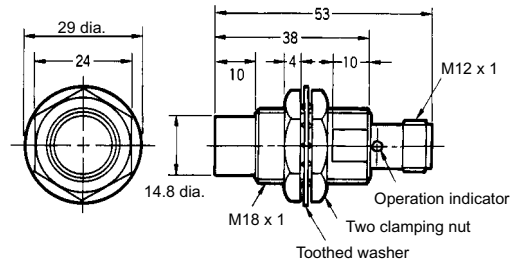
**Fig. 20 : E2E-X8MD□-M1G  
E2E-X5ME□-M1/F□-M1**



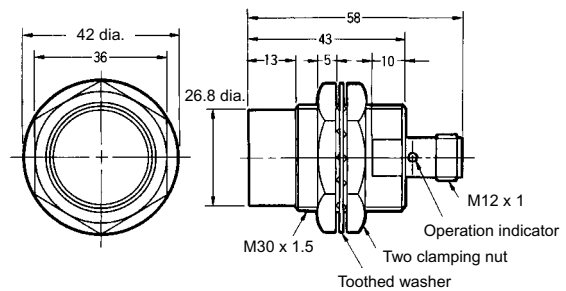
**Fig. 22 : E2E-X5MY□-M1**



**Fig. 24 : E2E-X14MD□-M1G/E2E-X10ME□-M1/F□-M1  
E2E-X10MY□-M1**

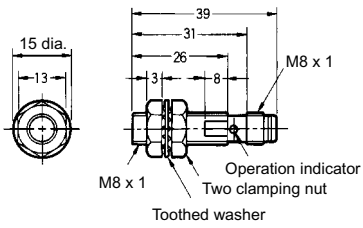


**Fig. 26 : E2E-X20MD□-M1G/E2E-X18ME□-M1/F□-M1  
E2E-X18MY□-M1**



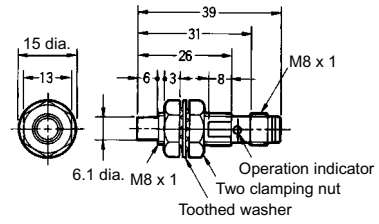
**M8 Connector Models  
(Shielded)**

**Fig. 27 : E2E-X2D□-M3G/E2E-X1R5E□-M3/F□-M3**



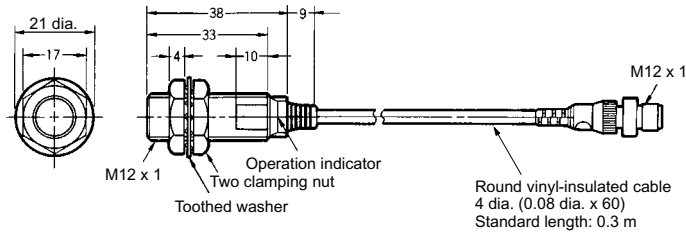
**M8 Connector Models  
(Unshielded)**

**Fig. 28 : E2E-X4MD□-M3G/E2E-X2ME□-M3/F□-M3**

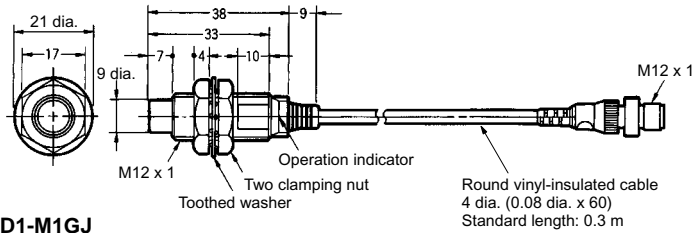


**Connector Extension Models**

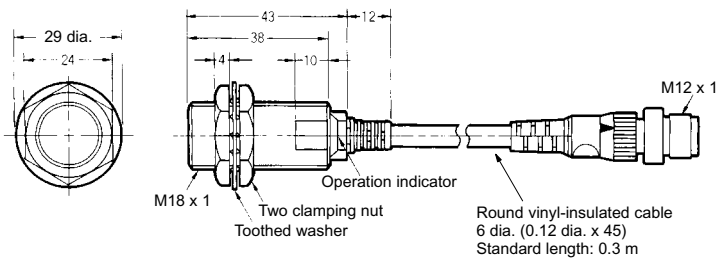
**Fig. 29 : E2E-X3D1-M1GJ  
E2E-X3D1-M1J-T**



**Fig. 30 : E2E-X8MD1-M1GJ**



**Fig. 31 : E2E-X7D1-M1GJ  
E2E-X7D1-M1J-T**





Connector Extension Models

Fig. 32 : E2E-X14MD1-M1GJ

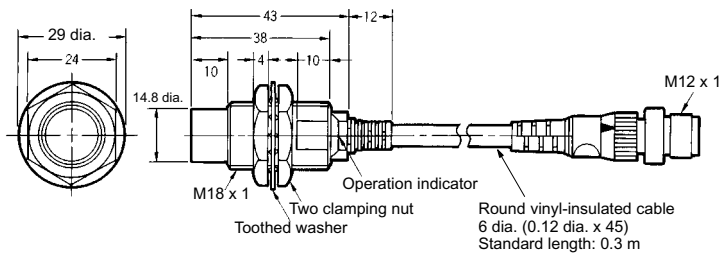


Fig. 33 : E2E-X10D1-M1GJ  
E2E-X10D1-M1J-T

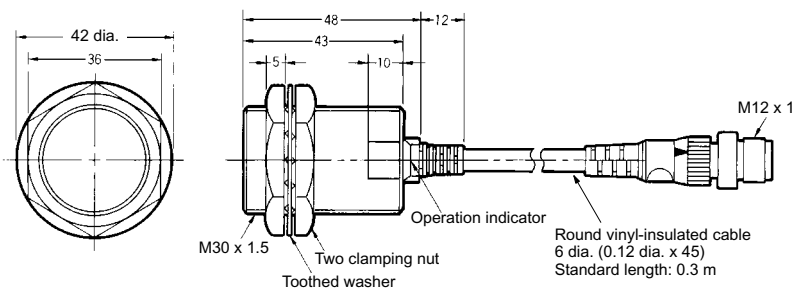
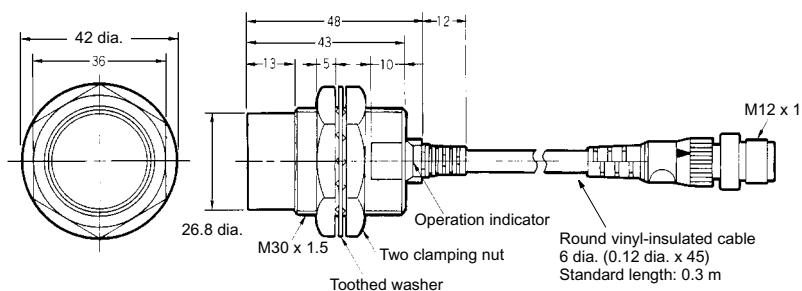
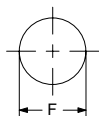


Fig. 34 : E2E-X20MD1-M1GJ



Mounting Holes

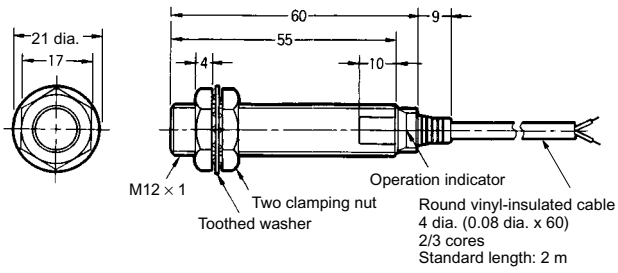


Dimensions	4 dia.	M5	5.4 dia.	M8	M12	M18	M30
F (mm)	4.2 <sup>+0.5/0</sup> dia.	5.5 <sup>+0.5/0</sup> dia.	5.7 <sup>+0.5/0</sup> dia.	8.5 <sup>+0.5/0</sup> dia.	12.5 <sup>+0.5/0</sup> dia.	18.5 <sup>+0.5/0</sup> dia.	30.5 <sup>+0.5/0</sup> dia.

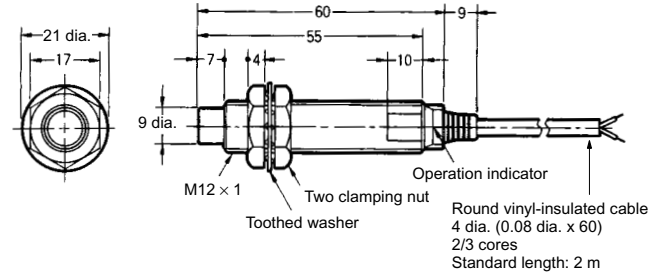
**E2E2**

**Pre-wired Models**

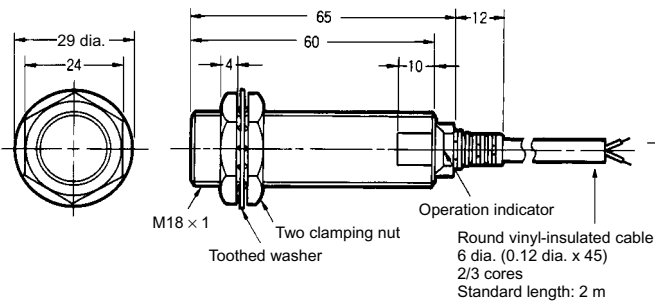
**E2E2-X3D** □  
**E2E2-X2** □ □



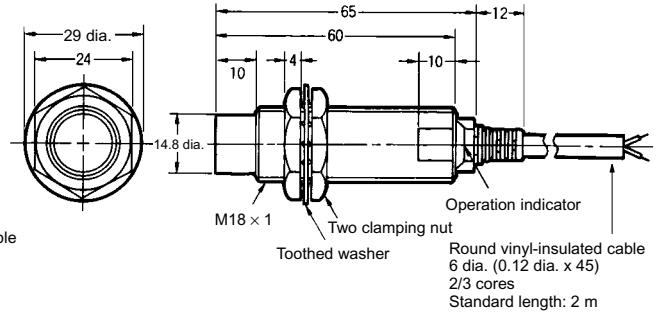
**E2E2-X8MD** □  
**E2E2-X5M** □ □



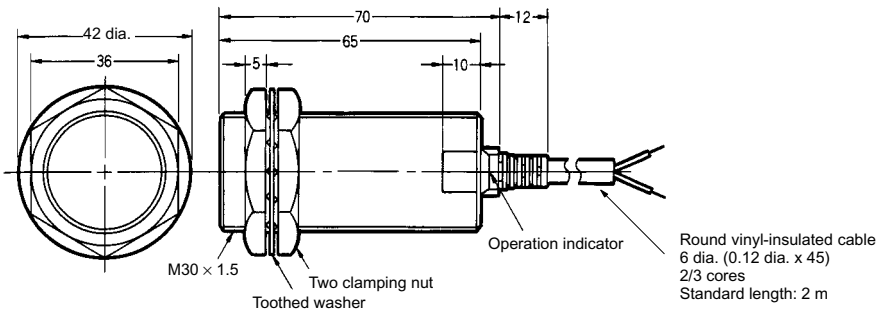
**E2E2-X7D** □  
**E2E2-X5** □ □



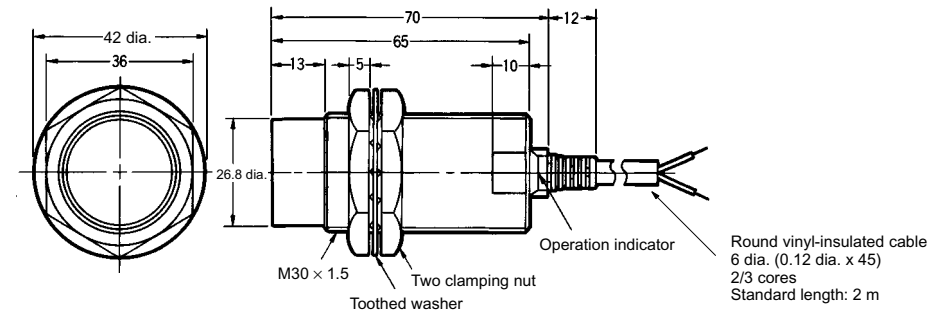
**E2E2-X14MD** □  
**E2E2-X10M** □ □



**E2E2-X10D** □ □

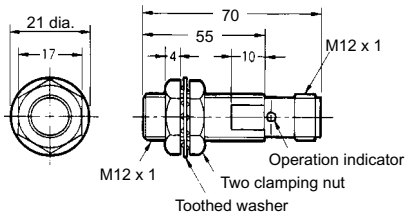


**E2E2-X20MD** □  
**E2E2-X18M** □ □

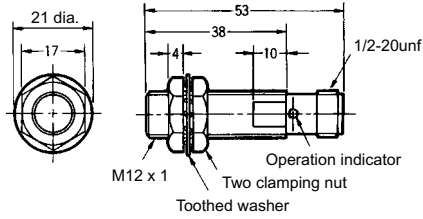


**Connector Models  
(Shielded)**

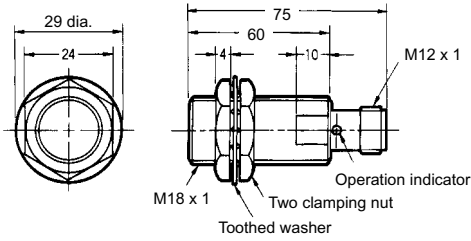
**E2E2-X2C□-M1/B□-M1**



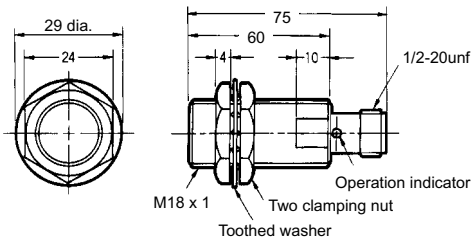
**E2E2-X2Y□-M4**



**E2E2-X5C□-M1/B□-M1**

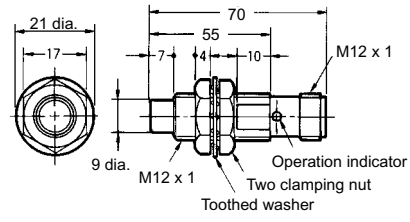


**E2E2-X5Y□-M4**

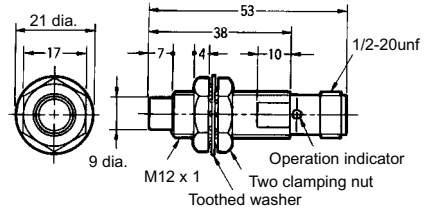


**Connector Models  
(Unshielded)**

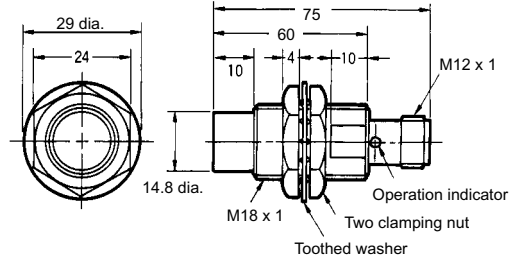
**E2E2-X5MC□-M1/B□-M1**



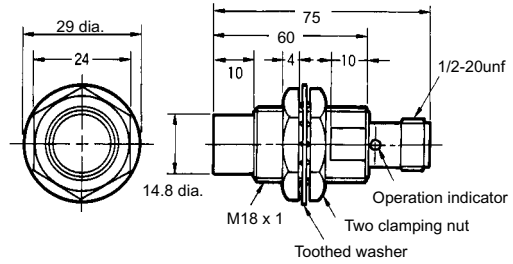
**E2E2-X5MY□-M4**



**E2E2-X10MC□-M1/B□-M1**

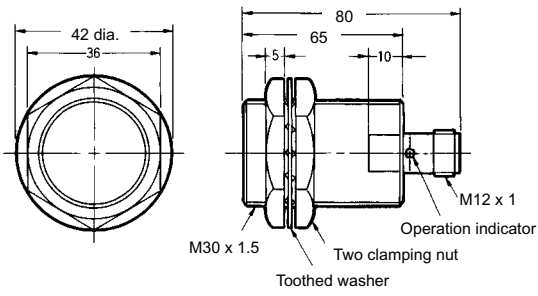


**E2E2-X10MY□-M4**



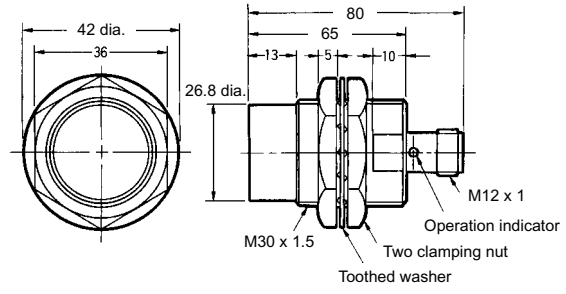
**Connector Models  
(Shielded)**

**E2E2-X10C□-M1/B□-M1**

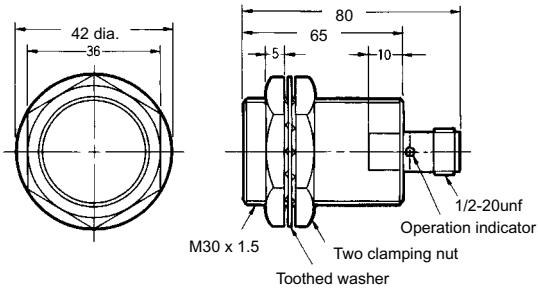


**Connector Models  
(Unshielded)**

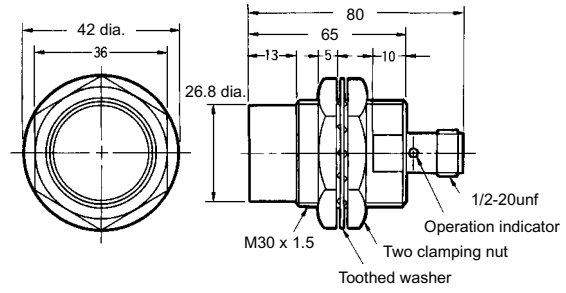
**E2E2-X18MC□-M1/B□-M1**



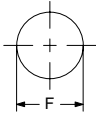
**E2E2-X10Y□-M4**



**E2E2-X18MY□-M4**



**Mounting Holes**



<b>Dimensions</b>	M12	M18	M30
<b>F (mm)</b>	12.5 dia.	18.5 dia.	30.5 dia.

# Installation

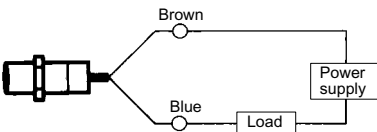
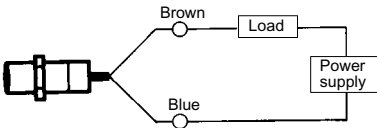
## ■ Connection

### E2E

**E2E-X□D□**  
DC 2-wire Models  
(Without Diagnostic Output)

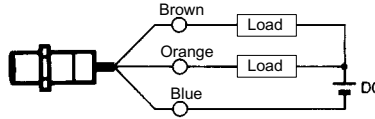
**E2E-X□Y□**  
AC 2-wire Models

**E2E-X□T1**  
AC/DC 2-wire Models



**Note:** The load can be connected as shown above.

**E2E-X□D1S**  
DC 3-wire Models  
(With Diagnostic Output)

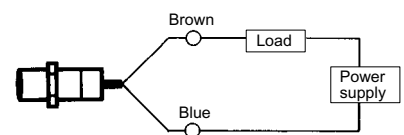


**Note:** The control output and diagnostic output share the negative common terminal. Therefore, the loads must be connected to the positive sides of the control output and diagnostic output.

**E2E-X□D1-M1J-1**  
DC 2-wire Models  
(No Polarity)

**E2E-X□Y□**  
AC 2-wire Models

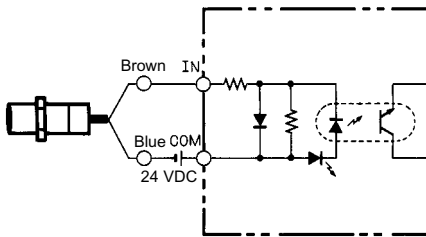
**E2E-X□T1**  
AC/DC 2-wire Models



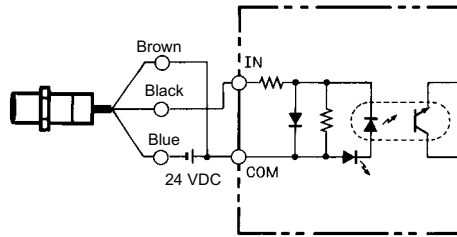
**Note:** There is no need to be concerned about the polarity (Brown/Blue) of the Proximity Sensor.

### Connected to PC

**E2E-X□D□**  
DC 2-wire Models

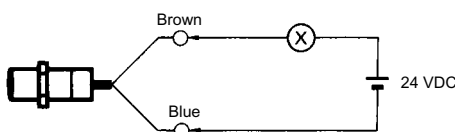


**E2E-X□E□**  
DC 3-wire Models

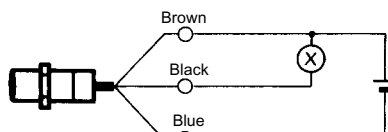


### Connected to Relay Load

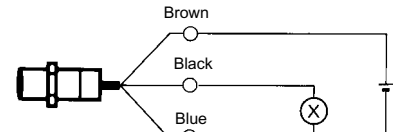
**E2E-X□D□**  
DC 2-wire Models



**E2E-X□E□**  
DC 3-wire Models

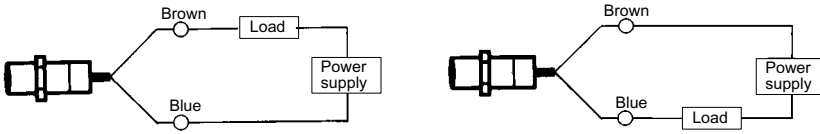


**E2E-X□F□**  
DC 3-wire Models



**E2E2**

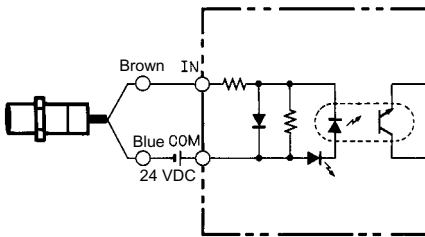
**E2E2-X□D□**  
**DC 2-wire Models**  
**E2E2-X□Y□**  
**AC 2-wire Models**



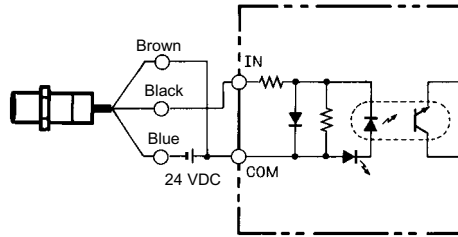
**Note:** The load can be connected as shown in the above diagrams.

**Connected to PC**

**E2E2-X□D□**  
**DC 2-wire Models**



**E2E2-X□C□**  
**DC 3-wire Models**



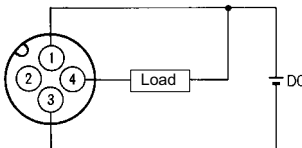
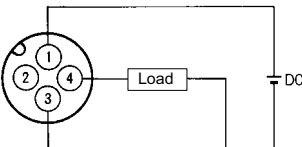
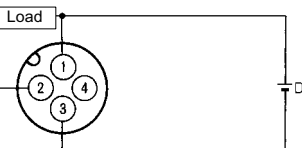
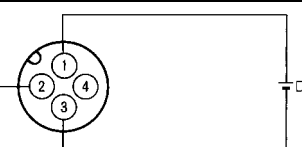
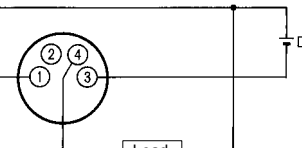
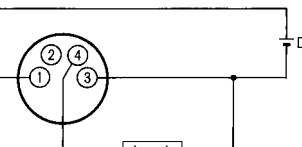
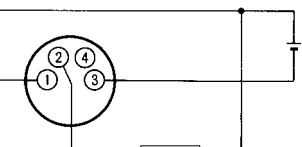
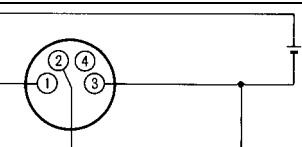
■ Pin Arrangement

E2E-X□D□-M□ DC 2-wire Models

Connector	Self-diagnostic output	Output configuration	Applicable models	Pin arrangement
M12	No	NO	E2E-X□D1-M1G□ (see note)	<p><b>Note:</b> Terminals 2 and 3 are not used.</p>
			E2E-X□D1-M1J-T	<p><b>Note:</b> 1. Terminals 1 and 2 are not used. 2. Terminals 3 and 4 has no polarity.</p>
			E2E-X□D1-M1	<p><b>Note:</b> Terminals 1 and 2 are not used.</p>
	Yes	NO	E2E-X□D2-M1G (see note)	<p><b>Note:</b> Terminals 3 and 4 are not used.</p>
			E2E-X□D2-M1	<p><b>Note:</b> Terminal 1 is not used.</p>
			E2E-X□D1S-M1	<p>(Control output)</p> <p><b>Note:</b> Terminals 1 and 4 are not used.</p>
M8	No	NO	E2E-X□D1-M3G	<p><b>Note:</b> Terminals 2 and 3 are not used.</p>
			NC	E2E-X□D2-M3G

**Note:** The above pin arrangements conform to IEC standards.

E2E-X□E□-M1 DC 3-wire Models

Connector	Output configuration	Applicable models	Pin arrangement
M12	NO	E2E-X□E1-M1	 <p><b>Note:</b> Terminal 2 is not used.</p>
		E2E-X□F1-M1	 <p><b>Note:</b> Terminal 2 is not used.</p>
	NC	E2E-X□E2-M1	 <p><b>Note:</b> Terminal 4 is not used.</p>
		E2E-X□F2-M1	 <p><b>Note:</b> Terminal 4 is not used.</p>
M8	NO	E2E-X□E1-M3	 <p><b>Note:</b> Terminal 2 is not used.</p>
		E2E-X□F1-M3	 <p><b>Note:</b> Terminal 2 is not used.</p>
	NC	E2E-X□E2-M3	 <p><b>Note:</b> Terminal 4 is not used.</p>
		E2E-X□F2-M3	 <p><b>Note:</b> Terminal 4 is not used.</p>



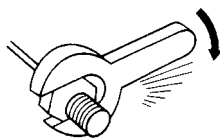
E2E-X□Y□-M1 AC 2-wire Models

Output configuration	Applicable models	Pin arrangement
NO	E2E-X□Y1-M1	<p><b>Note:</b> Terminals 1 and 2 are not used.</p>
NC	E2E-X□Y2-M1	<p><b>Note:</b> Terminals 3 and 4 are not used.</p>

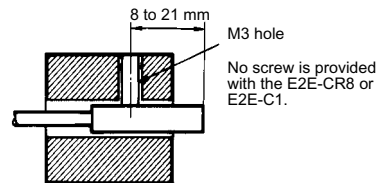
Precautions

**Mounting**

Do not tighten the nut with excessive force. A washer must be used with the nut.

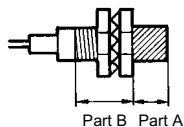


Refer to the following to mount the E2E-CR8 and E2E-C1 non-screw models.

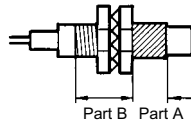


**E2E**

**Shielded Model**



**Unshielded Model**



Tighten the screw to a torque of 0.20 N • m (2 kgf • cm) maximum to secure the E2E-CR8 and a torque of 0.39 N • m (4 kgf • cm) maximum to secure the E2E-C1.

**E2E2**

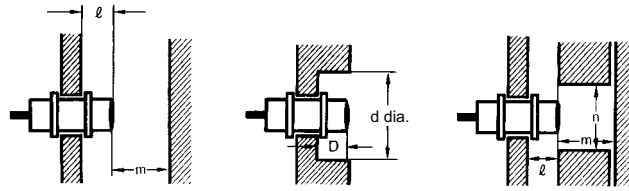
Type	Torque
M12	30 N • m (310 kgf • cm)
M18	70 N • m (710 kgf • cm)
M30	180 N • m (1,800 kgf • cm)

**Note:** The table below shows the tightening torques for part A and part B nuts. In the previous examples, the nut is on the sensor head side (part B) and hence the tightening torque for part B applies. If this nut is in part A, the tightening torque for part A applies instead.

Type		Part A		Part B
		Length	Torque	Torque
M8	Shielded	9 mm	9 N • m (90 kgf • cm)	12 N • m (120 kgf • cm)
	Unshielded	3 mm		
M12		29 N • m (300 kgf • cm)		
M18		69 N • m (700 kgf • cm)		
M30		176 N • m (1,800 kgf • cm)		

**Effects of Surrounding Metal**

When mounting the E2E within a metal panel, ensure that the clearances given in the following table are maintained. Failure to maintain these distances may cause deterioration in the performance of the sensor.



**E2E**

Type		Item	M8	M12	M18	M30
E2E-X□D□ DC 2-wire E2E-X□T1 AC/DC 2-wire	Shielded	ℓ	0 mm	0 mm	0 mm	0 mm
		d	8 mm	12 mm	18 mm	30 mm
		D	0 mm	0 mm	0 mm	0 mm
		m	4.5 mm	8 mm	20 mm	40 mm
		n	12 mm	18 mm	27 mm	45 mm
	Unshielded	ℓ	12 mm	15 mm	22 mm	30 mm
		d	24 mm	40 mm	70 mm	90 mm
		D	12 mm	15 mm	22 mm	30 mm
		m	8 mm	20 mm	40 mm	70 mm
		n	24 mm	40 mm	70 mm	90 mm
E2E-X□E□ E2E-X□F□ DC 3-wire E2E-X□Y□ AC 2-wire	Shielded	ℓ	0 mm	0 mm	0 mm	0 mm
		d	8 mm	12 mm	18 mm	30 mm
		D	0 mm	0 mm	0 mm	0 mm
		m	4.5 mm	8 mm	20 mm	40 mm
		n	12 mm	18 mm	27 mm	45 mm
	Unshielded	ℓ	6 mm	15 mm	22 mm	30 mm
		d	24 mm	40 mm	55 mm	90 mm
		D	6 mm	15 mm	22 mm	30 mm
		m	8 mm	20 mm	40 mm	70 mm
		n	24 mm	36 mm	54 mm	90 mm

**E2E2**

Type		Item	M12	M18	M30
E2E2-X□D□ DC 2-wire	Shielded	ℓ	0 mm	0 mm	0 mm
		d	12 mm	18 mm	30 mm
		D	0 mm	0 mm	0 mm
		m	8 mm	20 mm	40 mm
		n	18 mm	27 mm	45 mm
	Unshielded	ℓ	15 mm	22 mm	30 mm
		d	40 mm	70 mm	90 mm
		D	15 mm	22 mm	30 mm
		m	20 mm	40 mm	70 mm
		n	40 mm	70 mm	90 mm
E2E2-X□B□ E2E2-X□C□ DC 3-wire E2E2-X□Y□ AC 2-wire	Shielded	ℓ	0 mm	0 mm	0 mm
		d	12 mm	18 mm	30 mm
		D	0 mm	0 mm	0 mm
		m	8 mm	20 mm	40 mm
		n	18 mm	27 mm	45 mm
	Unshielded	ℓ	15 mm	22 mm	30 mm
		d	40 mm	55 mm	90 mm
		D	15 mm	22 mm	30 mm
		m	20 mm	40 mm	70 mm
		n	36 mm	54 mm	90 mm

## Relationship between Screw Sizes and Models

## E2E

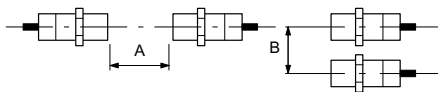
Type		Part number
M8	Shielded	E2E-X2D□ E2E-X1R5E□/F□ E2E-X1R5Y□
	Unshielded	E2E-X4MD□ E2E-X2ME□/F□ E2E-X2MY□
M12	Shielded	E2E-X3D□ E2E-X2E□/F□ E2E-X2Y□ E2E-X3T1
	Unshielded	E2E-X8MD□ E2E-X5ME□/F□ E2E-X3T1
M18	Shielded	E2E-X7D□ E2E-X5E□/F□ E2E-X5Y□ E2E-X7T1
	Unshielded	E2E-X14MD□ E2E-X10ME□/F□ E2E-X10MY□
M30	Shielded	E2E-X10D□ E2E-X10E□/F□ E2E-X10Y□ E2E-X10T1
	Unshielded	E2E-X20MD□ E2E-X18ME□/F□ E2E-X18MY□

## E2E2

Type		Part number
M12	Shielded	E2E2-X3D□ E2E2-X2C□/B□ E2E2-X2Y□
	Unshielded	E2E2-X8MD□ E2E2-X5MC□/B□ E2E2-X5MY□
M18	Shielded	E2E2-X7D□ E2E2-X5C□/B□ E2E2-X5Y□
	Unshielded	E2E2-X14MD□ E2E2-X10MC□/B□ E2E2-X10MY□
M30	Shielded	E2E2-X10D□ E2E2-X10C□/B□ E2E2-X10Y□
	Unshielded	E2E2-X20MD□ E2E2-X18MC□/B□ E2E2-X18MY□

### Mutual Interference

When installing two or more Sensors face to face or side by side, ensure that the minimum distances given in the following table are maintained.



#### E2E

Type		Item	M8	M12	M18	M30
E2E-X□D□ DC 2-wire	Shielded	A	20 mm	30 (20) mm	50 (30) mm	100 (50) mm
		B	15 mm	20 (12) mm	35 (18) mm	70 (35) mm
E2E-X□T1 AC/DC 2-wire	Unshielded	A	80 mm	120 (60) mm	200 (100) mm	300 (100) mm
		B	60 mm	100 (50) mm	110 (60) mm	200 (100) mm
E2E-X□E□ E2E-X□F□ DC 3-wire	Shielded	A	20 mm	30 (20) mm	50 (30) mm	100 (50) mm
		B	15 mm	20 (12) mm	35 (18) mm	70 (35) mm
E2E-X□Y□ AC 2-wire	Unshielded	A	80 mm	120 (60) mm	200 (100) mm	300 (100) mm
		B	60 mm	100 (50) mm	110 (60) mm	200 (100) mm

**Note:** The figures in parentheses refer to Sensors operating at different frequencies.

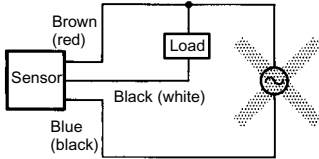
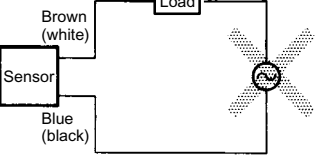
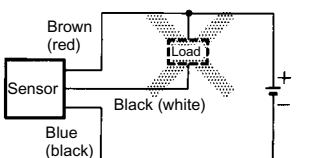
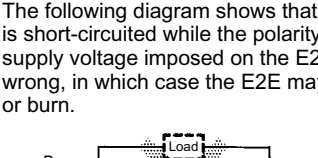
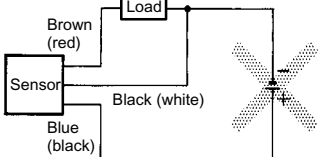
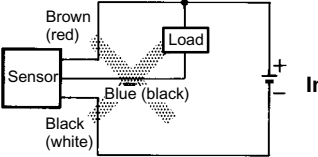
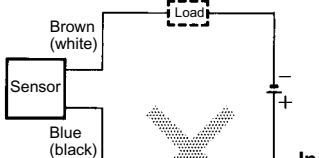
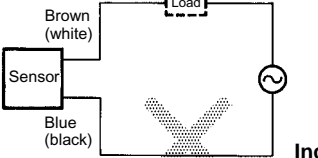
#### E2E2

Type		Item	M12	M18	M30
E2E2-X□D□ DC 2-wire	Shielded	A	30 (20) mm	50 (30) mm	100 (50) mm
		B	20 (12) mm	35 (18) mm	70 (35) mm
	Unshielded	A	120 (60) mm	200 (100) mm	300 (100) mm
		B	100 (50) mm	110 (60) mm	200 (100) mm
E2E2-X□B□ E2E2-X□C□ DC 3-wire	Shielded	A	30 mm	50 mm	100 mm
		B	20 mm	35 mm	70 mm
E2E2-X□Y□ AC 2-wire	Unshielded	A	120 mm	200 mm	300 mm
		B	100 mm	110 mm	200 mm

**Note:** The figures in parentheses refer to Sensors operating at different frequencies.

**! Caution**

The colors in parentheses are previous wire colors.

Item	Examples	
<p><b>Power supply</b></p> <p>Do not impose an excessive voltage on the E2E, otherwise it may explode or burn. Do not impose 100 VAC on any E2E DC model, otherwise it may explode or burn.</p>	<p>DC 3-wire models</p>  <p>Incorrect</p>	<p>DC 2-wire models</p>  <p>Incorrect</p>
<p><b>Load short-circuit</b></p> <p>Do not short-circuit the load, or the E2E may explode or burn.</p> <p>The E2E's short-circuit protection function is valid if the polarity of the supply voltage imposed is correct and within the rated voltage range.</p>	<p>DC 3-wire models</p>  <p>Incorrect</p>	<p>DC 2-wire models</p> <p>The following diagram shows that the load is short-circuited while the polarity of the supply voltage imposed on the E2E is wrong, in which case the E2E may explode or burn.</p>  <p>Incorrect</p>
<p><b>Wiring</b></p> <p>Be sure to wire the E2E and load correctly, otherwise it may explode or burn.</p>	<p>DC 3-wire models</p>  <p>Incorrect</p>	 <p>Incorrect</p>
<p><b>Connection with no load</b></p> <p>Make sure to connect a proper load to the E2E in operation, otherwise it may explode or burn.</p>	<p>DC 3-wire models</p>  <p>Incorrect</p>	<p>DC 2-wire models</p>  <p>Incorrect</p>

**■ Correct In Use Installation**

**Power Reset Time**

The Proximity Sensor is ready to operate within 100 ms after power is supplied. If power supplies are connected to the Proximity Sensor and load respectively, be sure to supply power to the Proximity Sensor before supplying power to the load.

**Power OFF**

The Proximity Sensor may output a pulse signal when it is turned off. Therefore, it is recommended to turn off the load before turning off the Proximity Sensor.

**Power Supply Transformer**

When using a DC power supply, make sure that the DC power supply has an insulated transformer. Do not use a DC power supply with an auto-transformer.

**Sensing Object**

**Metal Coating:**  
The sensing distances of the Proximity Sensor vary with the metal coating on sensing objects.

**Wiring**

**High-tension Lines**

**Wiring through Metal Conduit**

If there is a power or high-tension line near the cord of the Proximity Sensor, wire the cord through an independent metal conduit to prevent against Proximity Sensor damage or malfunctioning.

**Cord Tractive Force**

Do not pull cords with the tractive forces exceeding the following.

Diameter	Tractive force
4 dia. max.	30 N max.
4 dia. min.	50 N max.

**Mounting**

The Proximity Sensor must not be subjected to excessive shock with a hammer when it is installed, otherwise the Proximity Sensor may be damaged or lose its water-resistivity.

## Environment

### Water Resistivity

Do not use the Proximity Sensor underwater, outdoors, or in the rain.

## Operating Environment

Be sure to use the Proximity Sensor within its operating ambient temperature range and do not use the Proximity Sensor outdoors so that its reliability and life expectancy can be maintained. Although the Proximity Sensor is water resistive, a cover to protect the Proximity Sensor from water or water soluble machining oil is recommended so that its reliability and life expectancy can be maintained. Do not use the Proximity Sensor in an environment with chemical gas (e.g., strong alkaline or acid gasses including nitric, chromic, and concentrated sulfuric acid gases).

## Connecting Load to AC/DC 2-wire Sensor

Refer to the following before using AC or DC 2-wire Proximity Sensors.

### Surge Protection

Although the Proximity Sensor has a surge absorption circuit, if there is any machine that has a large surge current (e.g., a motor or welding machine) near the Proximity Sensor, connect a surge absorber to the machine.

### Leakage Current

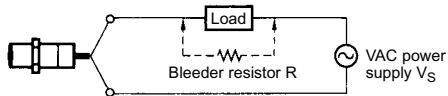
When the Proximity Sensor is OFF, the Proximity Sensor has leakage current. Refer to pages 17 and 21 Leakage Current Characteristics. In this case, the load is imposed with a small voltage and the load may not be reset. Before using the Proximity Sensor, make sure that this voltage is less than the load reset voltage. The AC 2-wire Proximity Sensor cannot be connected to any card-lift-off relay (e.g., the G2A) because contact vibration of the relay will be caused by the leakage current and the life of the relay will be shortened.

### Countermeasures Against Leakage Current

#### AC 2-wire Models

Connect a bleeder resistor as the bypass for the leakage current so that the current flowing into the load will be less than the load reset current.

As shown in the following diagram, connect the bleeder resistor so that the current flowing into the Proximity Sensor will be 10 mA minimum and the residual voltage imposed on the load will be less than the load reset voltage.



Refer to the following to calculate the bleeder resistance and the allowable power of the bleeder resistor.

$$R \cong V_S / (10 - I) \text{ (k}\Omega\text{)}$$

$$P > V_S^2 / R \text{ (mW)}$$

P: The allowable power of the bleeder resistor. (The actual power capacity of the bleeder resistor must be at least a few times as large as the allowable power of the bleeder resistor.)

I: Load current (mA)

The following resistors are recommended.

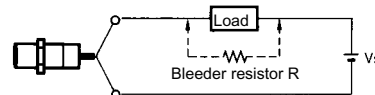
100 VAC (supply voltage): A resistor with a resistance of 10 k $\Omega$  maximum and an allowable power of 3 W minimum

200 VAC (supply voltage): A resistor with a resistance of 20 k $\Omega$  maximum and an allowable power of 10 W minimum

If these resistors generate excessive heat, use a resistor with a resistance of 10 k $\Omega$  maximum and an allowable power of 5 W minimum at 100 VAC and a resistor with a resistance of 20 k $\Omega$  maximum and an allowable power of 10 W minimum at 200 VAC instead.

#### DC 2-wire Models

Connect a bleeder resistor as the bypass for the leakage current so that the current flowing into the load will be less than the load reset current.



Refer to the following to calculate the bleeder resistance and the allowable power of the bleeder resistor.

$$R \cong V_S / (i_R - i_{OFF}) \text{ (k}\Omega\text{)}$$

$$P > V_S^2 / R \text{ (mW)}$$

P: The allowable power of the bleeder resistor. (The actual power capacity of the bleeder resistor must be at least a few times as large as the allowable power of the bleeder resistor.)

$i_R$ : Leakage current of Sensors (mA)

$i_{OFF}$ : Release current of load (mA)

The following resistors are recommended.

12 VDC (supply voltage): A resistor with a resistance of 15 k $\Omega$  maximum and an allowable power of 450 mW minimum

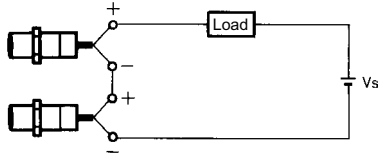
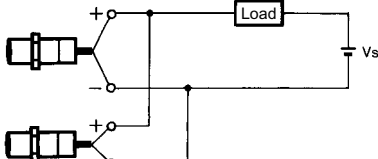
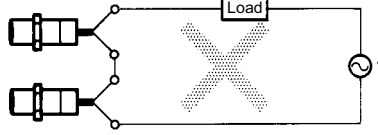
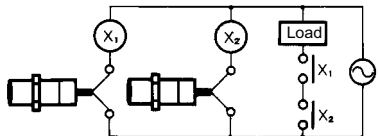
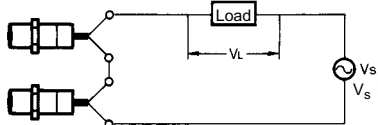
24 VDC (supply voltage): A resistor with a resistance of 30 k $\Omega$  maximum and an allowable power of 0.1 W minimum

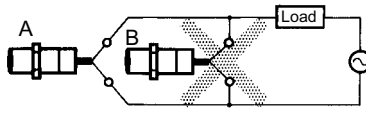
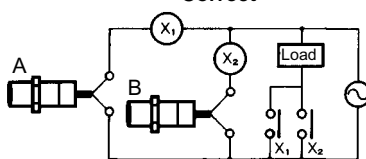
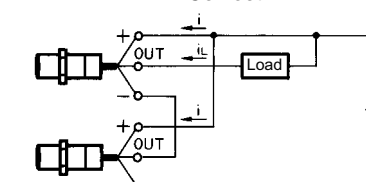
#### Inrush Current

A load that has a large inrush current (e.g., a lamp or motor) will damage the Proximity Sensor, in which case connect the load to the Proximity Sensor through a relay.

■ Precautions for AC/DC 2-wire Proximity Sensors in Operation

Connection

Model	Connection type	Method	Description
DC 2-wire	AND (serial connection)	<p><b>Correct</b></p> 	<p>The Sensors connected together must satisfy the following conditions.</p> $V_S - N \times V_R \geq \text{Load operating voltage}$ <p>N: No. of Sensors  <math>V_R</math>: Residual voltage of each Sensor  <math>V_S</math>: Supply voltage</p> <p>If each Proximity Sensor is not supplied with the rated voltage and current, the indicator will not be lit properly or unnecessary pulses may be output for approximately 1 ms.</p>
	OR (parallel connection)	<p><b>Correct</b></p> 	<p>The Sensors connected together must satisfy the following conditions.</p> $N \times i \leq \text{Load operating voltage}$ <p>N: No. of Sensors  <i>i</i>: Leakage current of each Sensor</p> <p>If the MY Relay, which operates at 24 VDC, is used as a load for example, a maximum of four Proximity Sensors can be connected to the load.</p>
AC 2-wire	AND (serial connection)	<p><b>Incorrect</b></p> 	<p>If 100 or 200 VAC is imposed on the Proximity Sensors, <math>V_L</math> (i.e., the voltage imposed on the load) will be obtained from the following.</p> $V_L = V_S - (\text{residual voltage} \times \text{no. of Proximity Sensors}) \text{ (V)}$ <p>Therefore, if <math>V_L</math> is lower than the load operating voltage, the load will not operate.</p> <p>A maximum of three Proximity Sensors can be connected in series provided that the supply voltage is 100 V minimum.</p>
		<p><b>Correct</b></p> 	
		 <p><math>V_S \approx 100 \text{ V}</math></p>	

Model	Connection type	Method	Description
AC 2-wire	OR (parallel connection)	<p style="text-align: center;"><b>Incorrect</b></p>  <p style="text-align: center;"><b>Correct</b></p>  <p style="text-align: right;">VAC power supply <math>V_S</math></p>	<p>In principle, more than two Proximity Sensors cannot be connected in parallel.</p> <p>Provided that Proximity Sensor A does not operate with Proximity Sensor B simultaneously and there is no need to keep the load operating continuously, the Proximity Sensors can be connected in parallel. In this case, however, due to the total leakage current of the Proximity Sensors, the load may not reset properly.</p> <p>It is not possible to keep the load operating continuously with Proximity Sensors A and B in simultaneous operation to sense sensing objects due to the following reason.</p> <p>When Proximity Sensor A is ON, the voltage imposed on Proximity Sensor A will drop to approximately 10 V and the load current flows into Proximity Sensor A, and when one of the sensing objects is close to Proximity Sensor B, Proximity Sensor B will not operate because the voltage imposed on Proximity Sensor B is 10 V, which is too low. When Proximity Sensor A is OFF, the voltage imposed on Proximity Sensor B will reach the supply voltage and Proximity Sensor B will be ON. Then, Proximity Sensor A as well as Proximity Sensor B will be OFF for approximately 10 ms, which resets the load for an instant. To prevent the instantaneous resetting of the load, use a relay as shown on the left.</p>
DC 3-wire	AND (serial connection)	<p style="text-align: center;"><b>Correct</b></p>  <p style="text-align: right;"><math>V_S</math></p>	<p>The Sensors connected together must satisfy the following conditions.</p> <p><math>i_L + (N - 1) \times i \leq</math> Upper-limit of control output of each Sensor</p> <p><math>V_S - N \times V_R \geq</math> Load operating voltage</p> <p>N: No. of Sensors</p> <p><math>V_R</math>: Residual voltage of each Sensor</p> <p><math>V_S</math>: Supply voltage</p> <p>i: Current consumption of the Sensor</p> <p><math>i_L</math>: Load current</p> <p>If the MY Relay, which operates at 24 VDC, is used as a load for example, a maximum of two Proximity Sensors can be connected to the load.</p>

**ALL DIMENSIONS SHOWN ARE IN MILLIMETERS.**  
 To convert millimeters into inches, multiply by 0.03937. To convert grams into ounces, multiply by 0.03527.

Cat. No. D058-E1-1C In the interest of product improvement, specifications are subject to change without notice.

**OMRON Corporation**

Industrial Sensors Division  
 Sensing Devices and Components Division H.Q.  
 28th Fl., Crystal Tower Bldg.,  
 1-2-27, Shiromi, Chuo-ku,  
 Osaka 540-6028 Japan  
 Phone: (81)6-949-6012 Fax: (81)6-949-6021

Printed in Japan  
 0698-0.5M (0296) Ⓐ