

## Miniature Inductive Prox

## TL-W

Subminiature, Flat-Pack DC Sensor  
Fits Tight Spaces

- Watertight construction conforms to IP67
- Space-saving mounting area, as small as 10 x 27 mm ( 0.39 x 1.06 in), is ideal for conveyor wall mounting
- Mounts directly onto metal base or rail
- Rugged diecast metal or low-profile plastic housing models available
- Choose NPN or PNP output models
- Ready to use: Prewired with 2 m (6.56 ft) length cable and mounting bracket included with TL-W3M sensors



## Ordering Information

Body type		Shielded	Unshielded		
Body material		Diecast aluminum	ABS plastic		
Nominal detecting distance		5 mm (0.20 in)	3 mm (0.12 in)	5 mm (0.20 in)	20 mm (0.79 in)
Part number	NPN-NO output	TL-W5E1	TL-W3MC1	TL-W5MC1	TL-W20ME1
	NPN-NC output	TL-W5E2	TL-W3MC2	TL-W5MC2	TL-W20ME2
	PNP-NO output	TL-W5F1	TL-W3MB1	TL-W5MB1	—
	PNP-NC output	TL-W5F2	—	—	—

# Specifications

## ■ UNSHIELDED, PLASTIC BODY SENSORS

Part number		TL-W3M□□	TL-W5M□□	TL-W20ME□
Sensor type		Inductive		
Body	Size	Flat, rectangular		
	Type	Unshielded		
Supply voltage		10 to 30 VDC, maximum ripple 10% peak-to-peak		
Current consumption		15 mA max.	10 mA max.	15 mA max.
Detectable object type		Metal objects		
Effective maximum detecting distance (with standard object)		0 to 2.7 mm (0 to 0.11 in)	0 to 4.5 mm (0 to 0.18 in)	0 to 16 mm (0 to 0.63 in)
Standard target size (mild steel, LxWxH)		12 x 12 x 1 mm (0.47 x 0.47 x 0.04 in)	18 x 18 x 1 mm (0.71 x 0.71 x 0.04 in)	50 x 50 x 1 mm (1.97 x 1.97 x 0.04 in)
Differential travel		10% max. of effective maximum detecting distance		
Control output	DC solid-state	Type	NPN-NO (TL-W□MC1) PNP-NO (TL-W□MB1)	
		Max. load	100 mA max.	50 mA max. at 12 VDC, 100 mA max. at 24 VDC
		Max. on-state voltage drop	1.0 V max.	
Response frequency		600 Hz	500 Hz	40 Hz
Circuit protection	Output short-circuit	Not provided		
	DC power supply reverse polarity	Provided		
Indicators		Target present (red LED)		
Materials	Housing	Plastic (ABS)		
	Sensing face	Plastic (ABS)		
	Cable sheath	Oil-proof vinyl		
Mounting		Bottom surface with 1 through hole, or mounting bracket supplied	Bottom surface with 2 through holes	
Connections	Prewired	3-conductor cable, 2 m (6.56 ft) length		
Weight with cable		30 g (1.06 oz.)	45 g (1.59 oz.)	180 g (6.35 oz.)
Enclosure ratings	UL	—		
	NEMA	1, 2, 3, 4X, 6, 12, 13		
	IEC 144	IP67		
Approvals	UL	—		
	CSA	—		
Ambient operating temperature		-25° to 70°C (-13° to 158°F)		
Vibration		10 to 55 Hz, at 1.5 mm in X, Y, and Z directions, double amplitude for 2 hours		
Shock		Approx. 50 G, three times		

■ SHIELDED, METAL BODY SENSORS

Part number		TL-W5E□□	TL-W5F□
Sensor type		Inductive	
Body	Size	Flat, rectangular	
	Type	Shielded	
Supply voltage		10 to 30 VDC, maximum ripple 10% peak-to-peak	
Current consumption		15 mA max. at 24 VDC	
Detectable object type		Metal objects	
Effective maximum detecting distance (with standard object)		0 to 4 mm (0 to 0.16 in)	
Standard target size (mild steel, LxWxH)		18 x 18 x 1 mm (0.71 x 0.71 x 0.04 in)	
Differential travel		10% max. at effective maximum detecting distance	
Control output	DC solid-state	Type	NPN-NO (TL-W5E1) with pull-up resistor NPN-NC (TL-W5E2) with pull-up resistor PNP-NO (TL-W5F1) with pull-down resistor PNP-NC (TL-W5F2) with pull-down resistor
		Max. load	200 mA max.
		Max. on-state voltage drop	2.0 V max.
Response frequency		300 Hz	
Circuit protection	Output short-circuit	Not provided	
	DC power supply reverse polarity	Provided	
Indicators		Target present (red LED)	
Materials	Housing	Diecast aluminum	
	Sensing face	Plastic (ABS)	
	Cable sheath	Oil-proof vinyl	
Mounting		Bottom surface with 2 through holes	
Connections	Prewired	3-conductor cable, 2 m (6.56 ft) length	
Weight with cable		70 g (2.5 oz.)	
Enclosure ratings	UL	—	
	NEMA	1, 2, 3, 4X, 6, 12, 13	
	IEC 144	IP67	
Approvals	UL	—	
	CSA	—	
Ambient operating temperature		-25° to 70°C (-13° to 158°F)	
Vibration		10 to 55 Hz, at 1.5 mm in X, Y, and Z directions, double amplitude for 2 hours	
Shock		Approx. 50 G, three hours	

## Operation

■ OUTPUT CIRCUIT DIAGRAMS

NPN Output TL-W□MC□

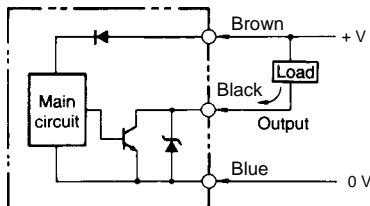

PNP Output TL-W□MB□

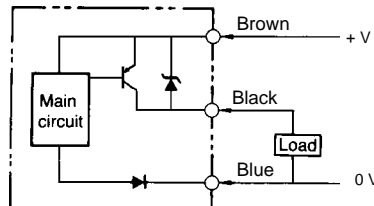

OUTPUT CIRCUIT DIAGRAMS (continued)

NPN Output TL-W5E□, TL-W20ME□

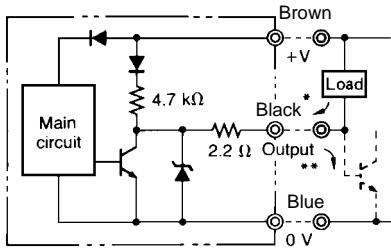

\* 200 mA max. (load current)  
\*\* When a transistor is connected

PNP Output TL-W5F□

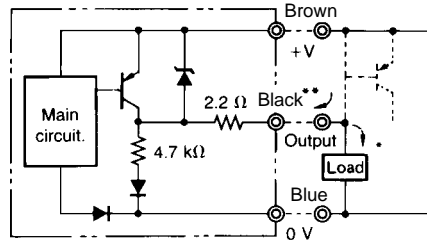

\* 200 mA max. (load current)  
\*\* When a transistor is connected

■ TIMING CHARTS

TL-W3M, TL-W5M

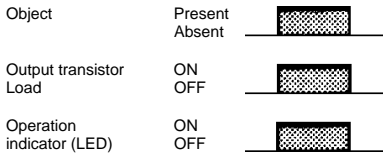

NPN Output TL-W5E□, TL-W20ME□

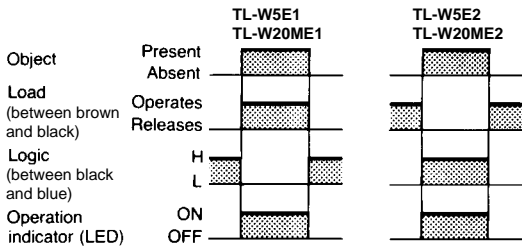

PNP Output TL-W5F□

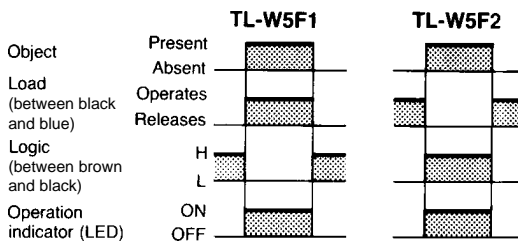

Engineering Data

■ OPERATING RANGE

TL-W3M□

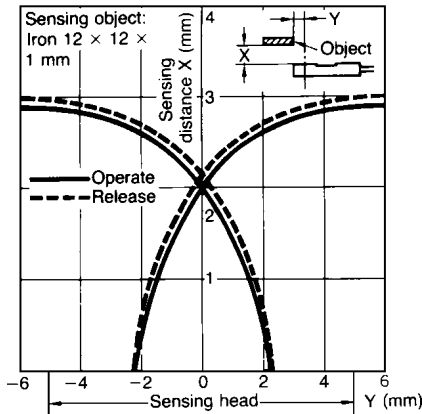

TL-W5M□

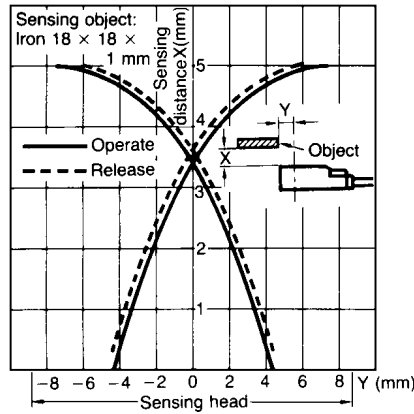

TL-W5□□

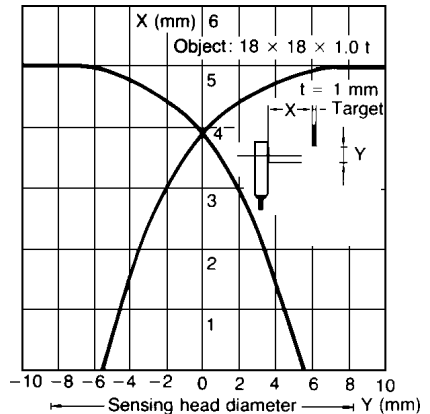

TL-W20M□□

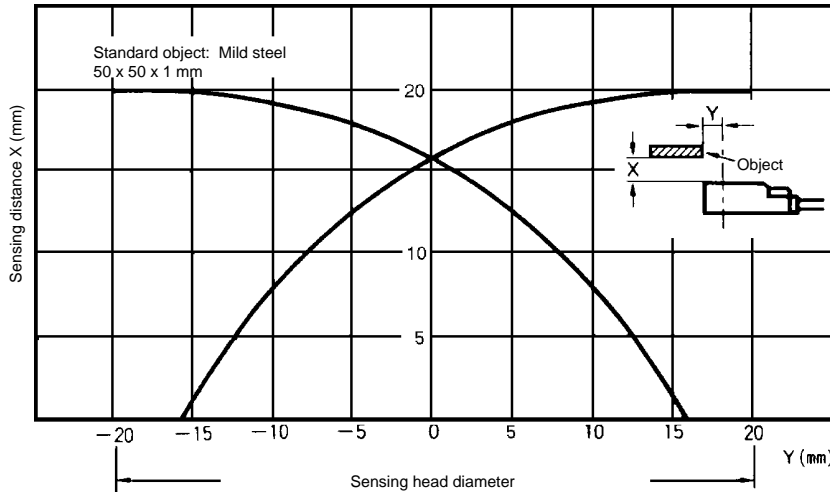

■ SENSITIVITY

TL-W3M□1

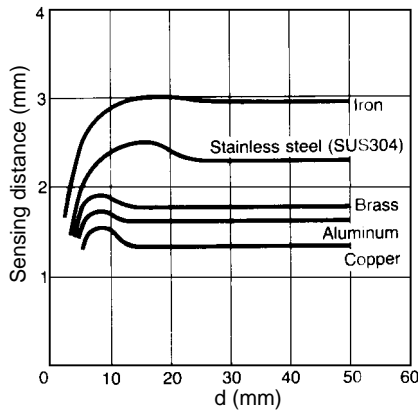

TL-W5M□1

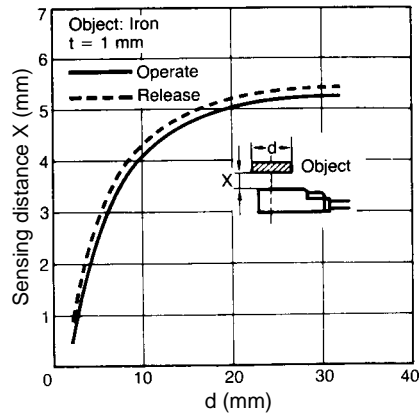

TL-W5□

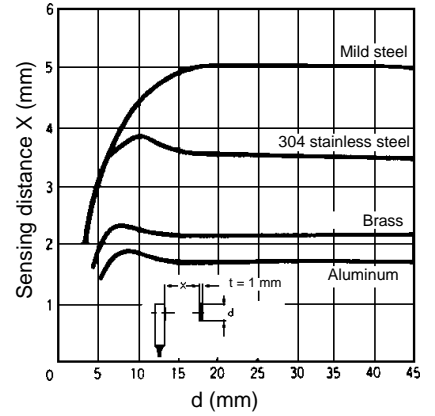

TL-W20M□

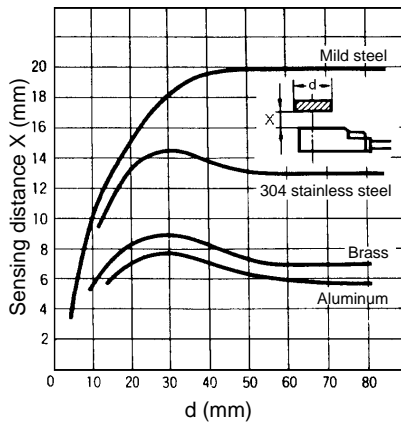

# Dimensions

Unit: mm (inch)

## TL-W3M□1

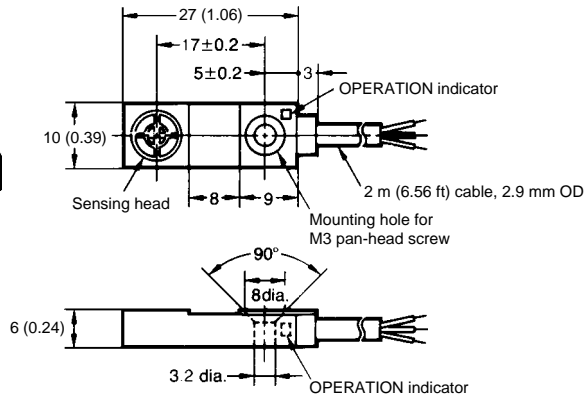
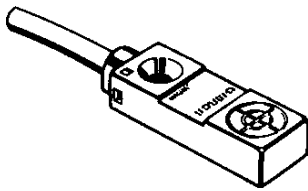

### Mounting bracket (included)

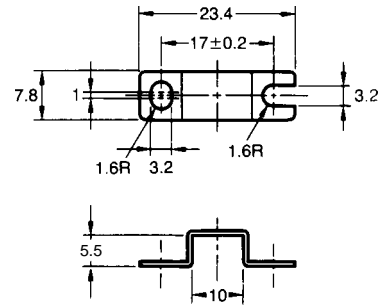

## TL-W5M□1

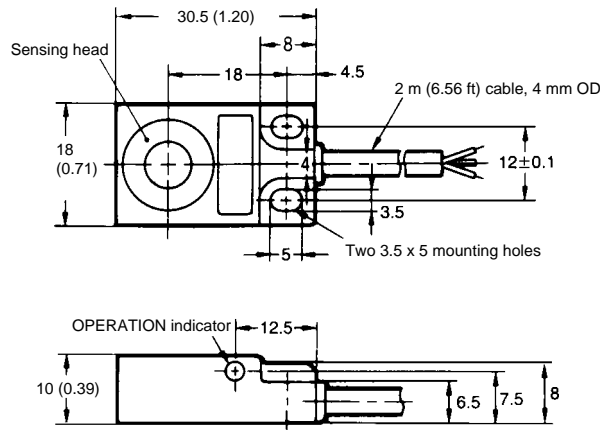
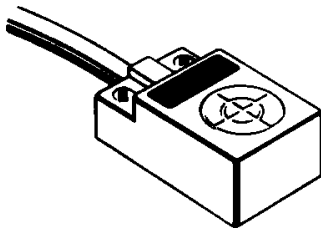

## TL-W5E, TL-W5F

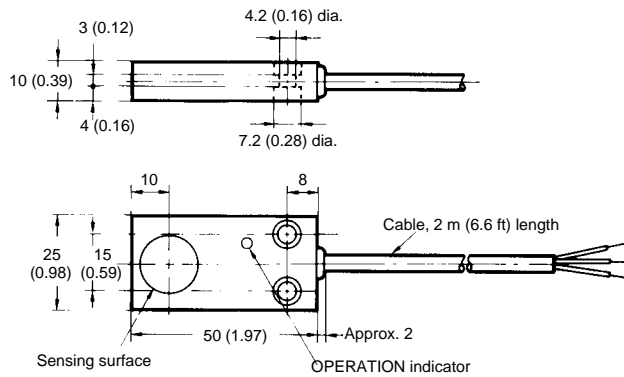
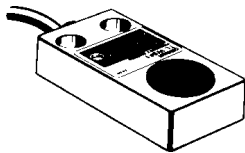

### Mounting holes

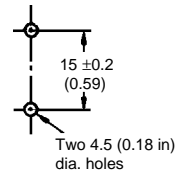

TL-W20ME□

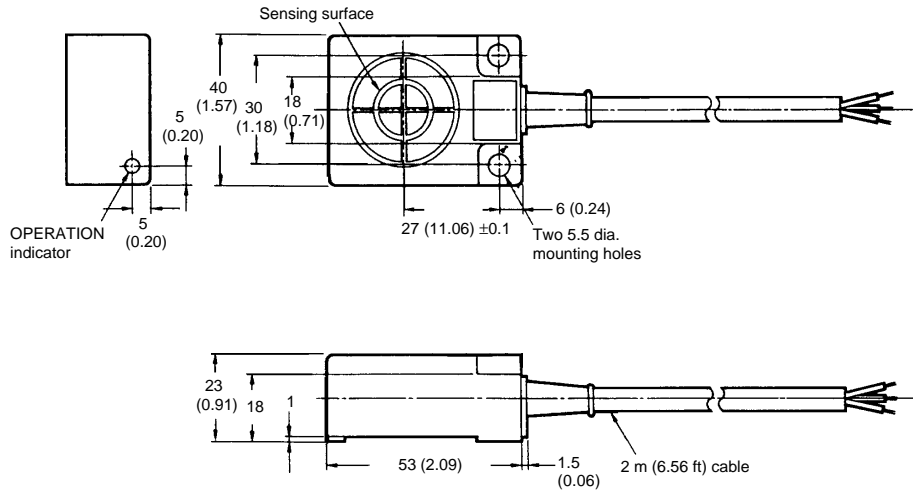
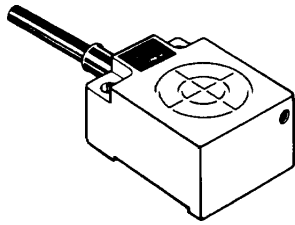

# Precautions

## ■ INFLUENCE OF SURROUNDING METALS

When mounting the proximity sensor flush with a metallic panel, be sure to allow a minimum distance as shown in the table below. If the other side is open, the value of "l" is zero.

Distance	"l"	n
TL-W3M	3 mm (0.12 in)	12 mm (0.47 in)
TL-W5M	5 mm (0.20 in)	20 mm (0.79 in)
TL-W20M	25 mm (0.98 in)	100 mm (0.34 in)

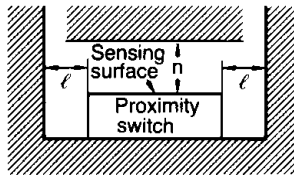

## ■ MUTUAL INTERFERENCE

When mounting two or more sensors of the same type face to face or side by side, be sure to provide a minimum distance as shown in the table below.

Distance	A	B
TL-W3M	90 mm (3.54 in)	30 mm (1.18 in)
TL-W5M	120 mm (4.72 in)	60 mm (2.36 in)
TL-W5□	50 mm (1.97 in)	35 mm (1.38 in)
TL-W20M	200 mm (7.87 in)	200 mm (7.87 in)

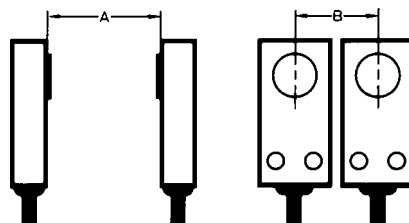

NOTE: DIMENSIONS ARE SHOWN IN MILLIMETERS. To convert millimeters to inches divide by 25.4.

**OMRON**

**OMRON ELECTRONICS, INC.**

One East Commerce Drive  
Schaumburg, IL 60173

**1-800-55-OMRON**

**OMRON CANADA, INC.**

885 Milner Avenue  
Scarborough, Ontario M1B 5V8

**416-286-6465**