





Sensing distance	Supply voltage	Output
 1.0 mm, 1.5 mm, 2.5 mm, 5.0 mm	12 to 24 VDC	 100 mA max., 2 outputs

## Special-Purpose Proximity Sensor

## E2CD

### High-Precision Sensor for Accurate Positioning and Inspection of Objects

- High repeat accuracy,  $\pm 1$  to  $5 \mu\text{m}$  ( $\pm 0.00004$  to  $0.0002$  inch)
- Low temperature drift ( $0.8 \mu\text{m}/^\circ\text{C}$ ) using 5.4 mm diameter sensor
- Digital setting method with Teach function allows faster, more accurate setup
- Built-in controller with two independent outputs provides features usually requiring a separate controller for inspection
- Detects ferrous and non-ferrous metals with little difference in sensing distance



## Ordering Information

### ■ SENSORS

Each of the part numbers below represents a set consisting of a sensor and an amplifier/controller. To obtain the precision performance, sensors and amplifiers are not sold separately.

Sensing head		Nominal detecting distance	Part number
Size	Type		
5.4 mm (0.21 in) dia.	Shielded, unthreaded	0 to 1.0 mm (0 to 0.039 in)	E2CD-C1C3A
8 mm (0.23 in) dia.	Shielded, unthreaded	0 to 1.5 mm (0 to 0.059 in)	E2CD-C1R5C3A
M12	Shielded, threaded	0 to 2.5 mm (0 to 0.098 in)	E2CD-X2R5C3A
M18	Shielded, threaded	0 to 5.0 mm (0 to 0.197 in)	E2CD-X5C3A

### ■ ACCESSORIES

Description	Part number
Mounting bracket for M12 size sensor	Y92E-B12
Mounting bracket for M18 size sensor	Y92E-B18

# Specifications

Part number		E2CD-C1C3A	E2CD-C1R5C3A	E2CD-X2R5C3A	E2CD-X5C3A
Sensor type		Shielded			
Body	Size	5.4 mm (0.21 in) dia.	8 mm (0.23 in) dia.	M12	M18
	Type	Unthreaded		Threaded	
Supply voltage		12 to 24 VDC (10 to 30 VDC), ripple (p-p): 10% max.			
Current consumption		65 mA max.			
Detectable object type		Ferrous and non-ferrous metals			
Usable sensing distance at ambient (with standard target)		0 to 1 mm	0 to 1.5 mm	0 to 2.5 mm	0 to 5 mm
Standard target size (L x W x H)		Iron, 5 x 5 x 1 mm (0.20 x 0.20 x 0.04)	Iron, 8 x 8 x 1 mm (0.32 x 0.32 x 0.04)	Iron, 12 x 12 x 1 mm (0.47 x 0.47 x 0.04)	Iron, 18 x 18 x 1 mm (0.71 x 0.71 x 0.04)
Differential travel		5 µm max.	10 µm max.	12 µm max.	30 µm max.
Guaranteed accuracy range		0.4 to 0.6 mm (0.016 to 0.024)	0.6 to 0.9 mm (0.024 to 0.035)	1.0 to 1.5 mm (0.039 to 0.059)	2.0 to 3.0 mm (0.079 to 0.118)
Repeatability		±1 µm	±1.5 µm	±2 µm	±5 µm
Resolution		0.5 µm	1 µm	2 µm	5 µm
Influence of temperature		0.8 µm/°C	1.5 µm/°C		
Control output	DC solid-state	Type	2 NPN open collector outputs		
		Max. load	100 mA max.		
		Residual voltage	1.0 V max		
Response time		Sampling time: 8 ms			
Circuit protection		Output short circuit, reverse polarity, surge voltage			
Gate input on amplifier	ON level	0 to 4 V (5 mA min.)			
	OFF level	7 to 24 V (2 mA max.)			
	Pulse width	2.5 ms min.			
Diagnostic functions		Output load short-circuit, sensor error, memory error, and CPU error			
Indicators on amplifier		Green: Power; Red: Error; Orange: Zone (HIGH, PASS, and LOW)			
Materials	Sensor	Nickel-plated brass			
	Amplifier	Plastic			
Mounting	Sensor	—		Two lock washers and M12 nuts included; Y92E-B12 bracket optional	Two lock washers and M18 nuts included; Y92E-B18 bracket optional
	Amplifier	DIN rail or surface mounting			
Connections	Sensor	Plug-in adapter			
	Amplifier	Screw terminals			
Weight		190 g (6.7 oz)	200 g (7.1 oz)	220 g (7.8 oz)	250 g (8.8 oz)
Enclosure ratings	UL	—			
	NEMA	—			
	IEC 144	IP67 for sensors; IP30 for amplifier			
Approvals	UL	—			
	CSA	—			
Ambient operating temperature		Sensor operating: -10°C to 60°C (14° to 140°F) with no icing Amplifier operating: -10°C to 55°C (14° to 131°F) with no icing			
Vibration		Sensor (destruction): 10 to 55 Hz, 3.0-mm double amplitude for 2 hrs each in X, Y, and Z directions Amplifier (destruction): 10 to 150 Hz, 1.5-mm double amplitude for 2 hrs each in X, Y, and Z directions			
Shock		Sensor (destruction): 100G, 3 times each in X, Y, and Z directions Amplifier (destruction): 30G, 3 times each in X, Y, and Z directions			

Note: 1. The above specifications are guaranteed on condition that the sensing object is located within the guaranteed accuracy range.  
2. Be sure to use a right combination of a sensor and amplifier or the operation accuracy of the sensor will not be maintained.

# Engineering Data

## ■ OPERATING RANGE (Typical)

E2CD-C1C3A

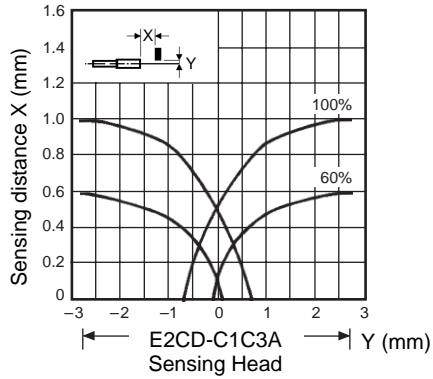

E2CD-C1R5C3A

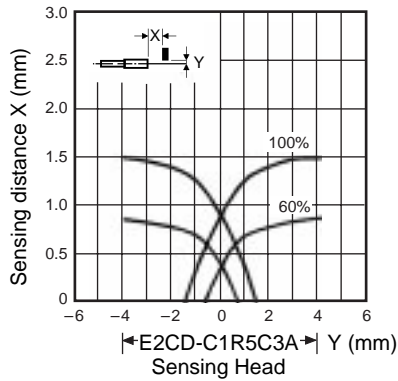

E2CD-X2R5C3A

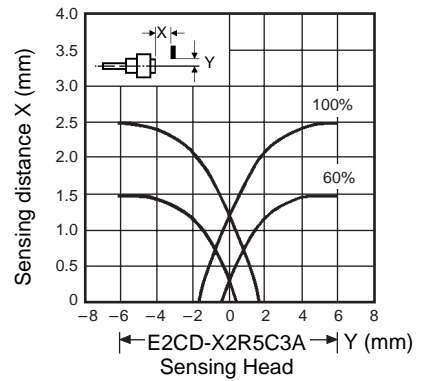

## OPERATING RANGE (Typical)

## ■ SENSING DISTANCE VS. SENSING OBJECT (Typical)

E2CD-X5C3A

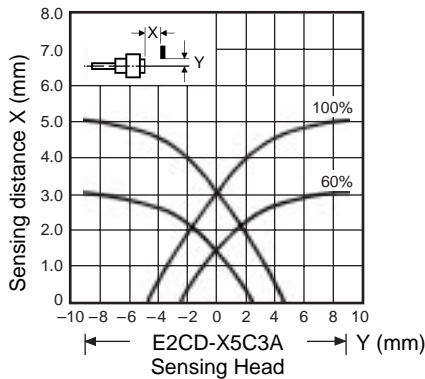

E2CD-C1C3A

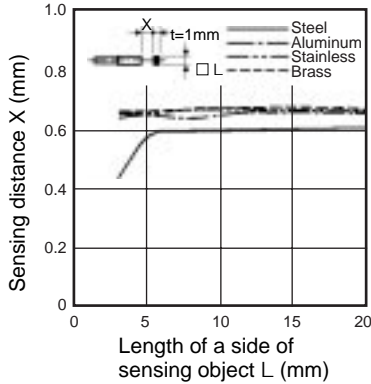

E2CD-C1R5C3A

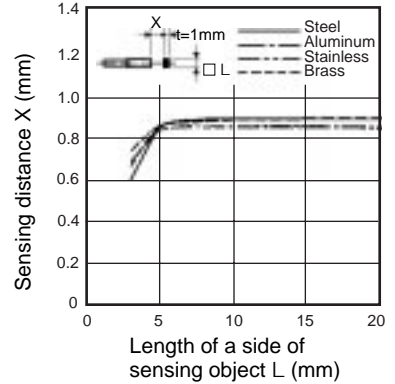

## SENSING DISTANCE VS. SENSING OBJECT (Typical)

## ■ TEMPERATURE CHARACTERISTICS (Typical)

E2CD-X2R5C3A

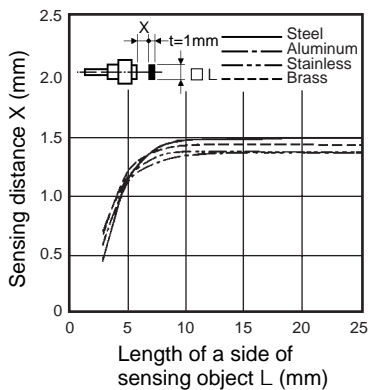

E2CD-X5C3A

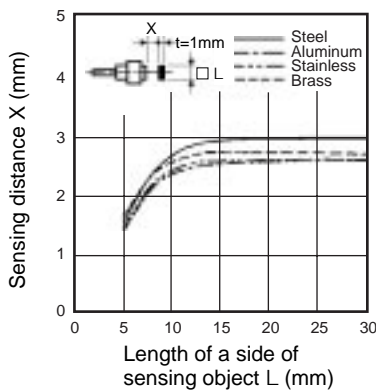

E2CD-C1C3A

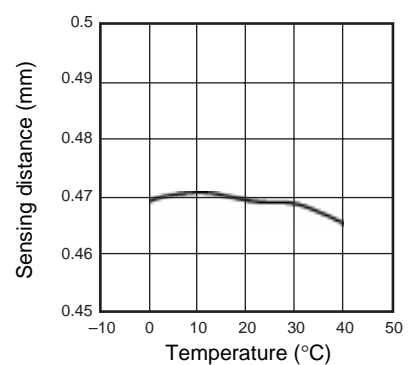

Note: The sensing distance is 60% of the rated sensing distance.

TEMPERATURE CHARACTERISTICS (Typical) (continued)

E2CD-C1R5C3A

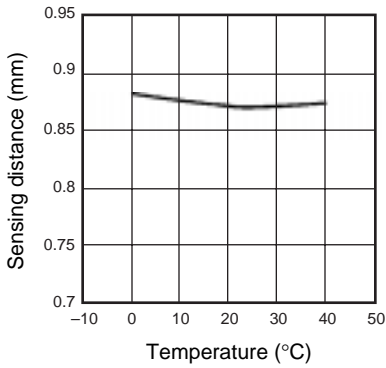

E2CD-X2R5C3A

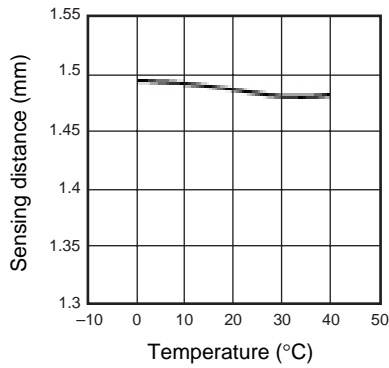

E2CD-X5C3A

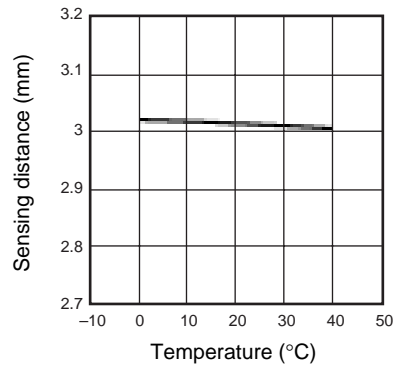

Dimensions

Unit: mm (inch)

■ SENSORS

E2CD-C1C3A

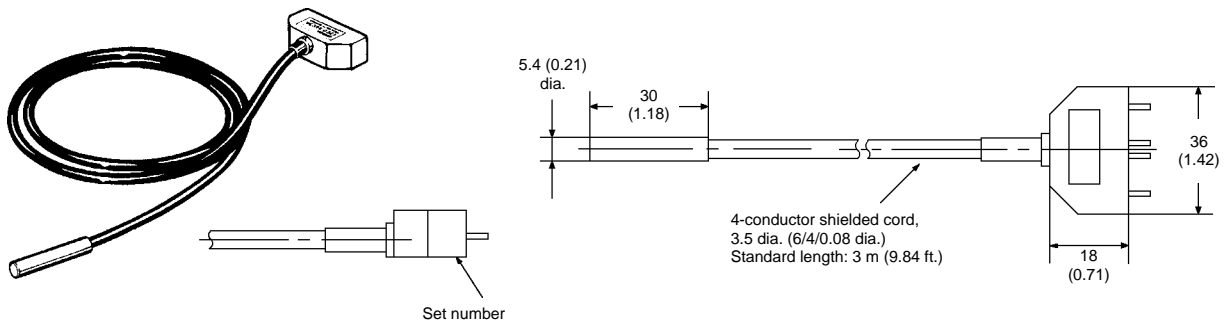

E2CD-C1R5C3A

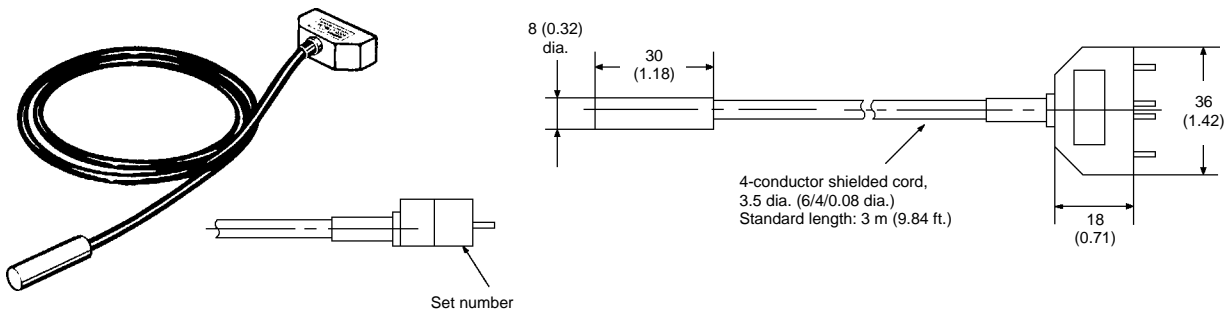

**SENSORS (continued)**

**E2CD-X2R5C3A**

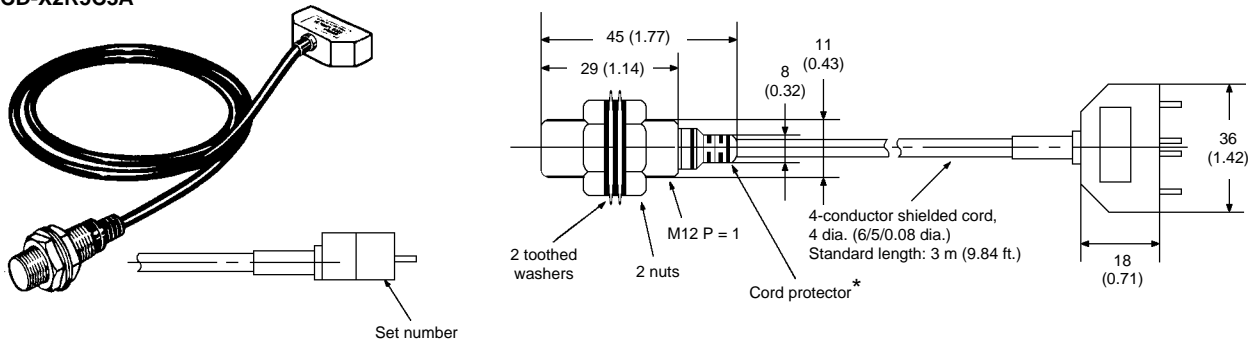

**E2CD-X5C3A**

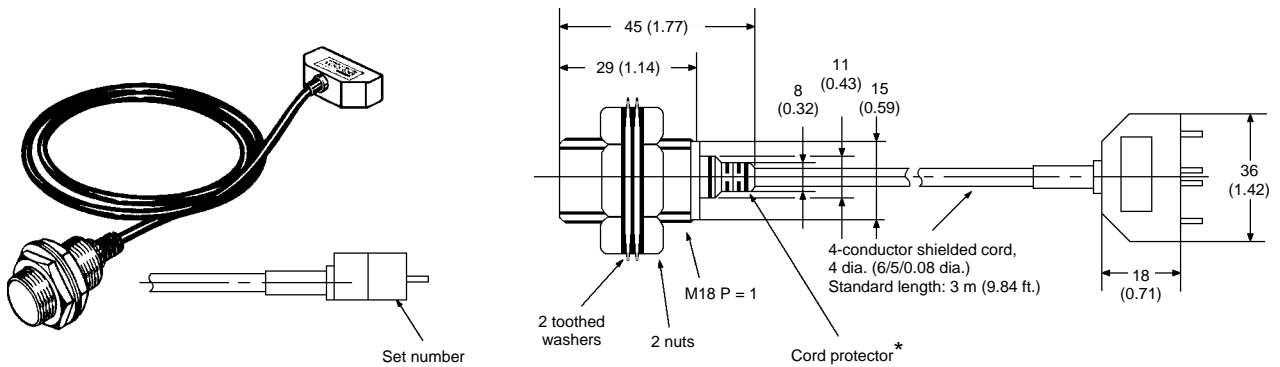

\*The cord protector protects the cord from being bent or damaged. There is some space between the cord protector and the sensor. This space will not, however, affect the enclosure protection of the sensor.

**■ AMPLIFIERS**

- E2CD-C1C3A
- E2CD-C1R5C3A
- E2CD-X2R5C3A
- E2CD-X5C3A

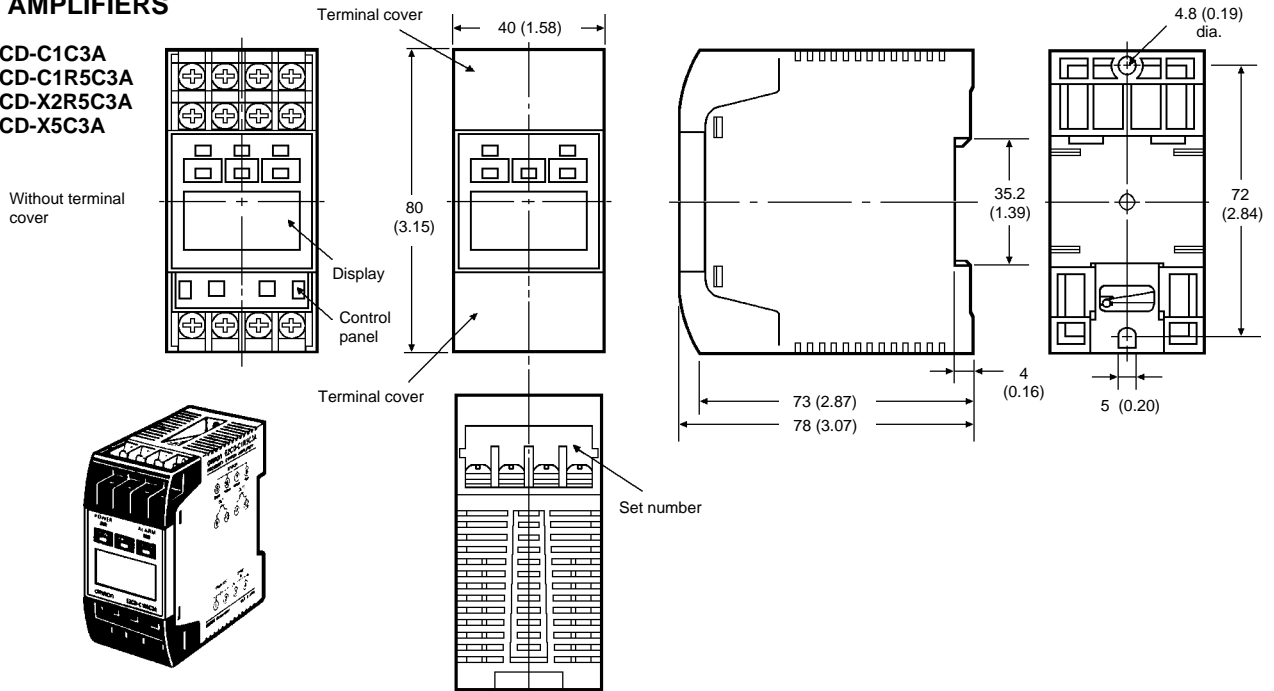

Note: 1. Use the right combination of an E2CD sensor and amplifier, both of which have the same identification number. The identification number is printed on the back of the cord adapter of the sensor and on one of the sides of the amplifier.  
2. Do not cut off or extend the sensor cord, otherwise the characteristics of the sensor cord will change and the specifications of the E2CD will no longer be guaranteed.

## OPTIONAL MOUNTING BRACKETS

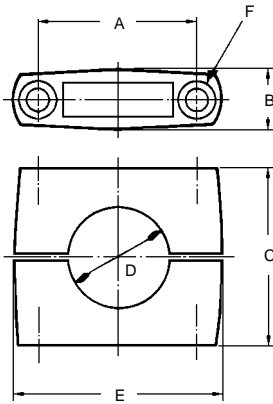

Part number	Drawing dimensions						Applicable sensor models
	A	B	C	D	E	F	
Y92E-B12	24 ± 0.2 (0.94 ± 0.01)	12.5 (0.49) max.	20 (0.79)	12 (0.47) dia.	37 (1.46) max.	M4 x 25 bolt	E2CD-X2R5C3A
Y92E-B18	32 ± 0.2 (1.26 ± 0.01)	17 (0.67) max.	30 (1.18)	18 (0.71) dia.	47 (1.85) max.	M5 x 32 bolt	E2CD-X5C3A

## Nomenclature

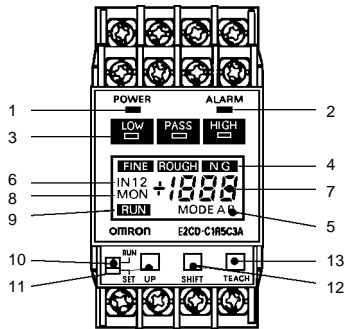

- 1: POWER indicator
- 2: ALARM indicator
- 3: Zone indicators
- 4: Set value zone indicators
- 5: MODE indicator
- 6: Set input indicator
- 7: Value indicator
- 8: Monitor
- 9: RUN indicator
- 10: Operation mode selector
- 11: UP Key
- 12: SHIFT Key
- 13: TEACH Key

## LED DISPLAY

### Power Indicator (Green LED)

Lit when the power is supplied to the sensor.

### ALARM Indicator (Red LED)

Flashes when an error occurs, at which time sensor outputs will be OFF and the LCD will display the following error messages.

Kind of error	LCD	Resetting method
Output load short-circuited	E1 (flashes)	Automatically reset when the short-circuited load is reset.
Sensor error (wire disconnection, wrong connection, temperature rise)	E2 (flashes)	Automatically reset when the sensor error is corrected.
User memory data error	E3 (flashes)	Re-input the data.
OS memory data error	E4 (flashes)	Impossible to reset.
CPU error	E5 (flashes)	Impossible to reset.

### Zone Indicators (Orange LED)

No indicators are lit when the synchronization input is OFF.

LOW is lit when the sensing object is nearer than the point set by set value 1 (output 1 is ON).

PASS is lit when the sensing object is between the points set by set values 1 and 2 (output 1 and output 2 are OFF).

HIGH is lit when the sensing object is farther than the point set by set value 2 (output 2 is ON).

## ■ SELECTOR

### Operation Mode Selector

Select one of the following modes with the operation mode selector.

**RUN:** The sensor operates. No program input is accepted.

**SET:** Select this mode for setting values. The set values will be written to the memory when the operation mode is changed to RUN from SET.

### UP KEY

**SET Mode:** Used to change the mode setting or set value.

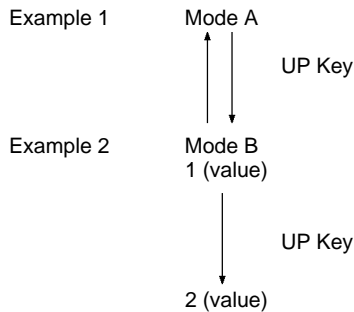

**RUN Mode:** Used to change the contents of the display.

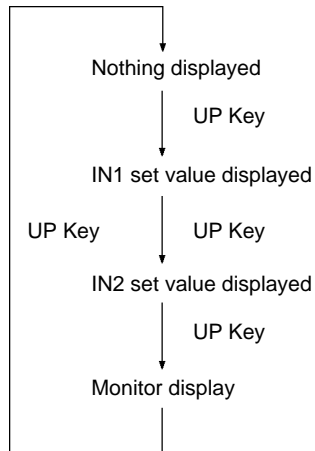

### SHIFT Key

Used to finalize the mode or value setting or to shift to the next digit.

### TEACH Key

Used in the teaching mode. With the teaching function, the set value will be input by locating the sensing object at an appropriate position and pressing the TEACH Key. No set value can be input if the sensing object is outside the sensing range.

## ■ LCD DISPLAY

### Set Value Zone Indicators (SET Mode only)

Displays the location of the set values in the sensing range.

**FINE:** Displayed when the set values are in the guaranteed accuracy range.

**ROUGH:** Displayed when the set values are outside the guaranteed accuracy range, but within the sensing range.

**NG:** Displayed when the set values are outside the sensing range. However, no program error will result even if NG is displayed.

Example 1: FINE is displayed if set values 1 and 2 are within the guaranteed accuracy range.

Example 2: FINE and NG are displayed if one of the set values is within the guaranteed accuracy range and the other is outside the sensing range.

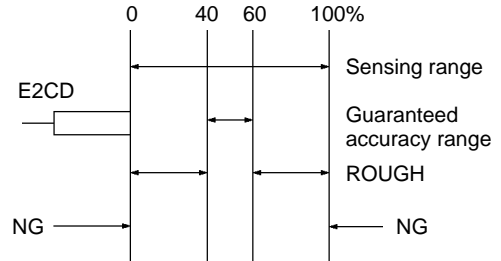

### MODE Indicator

Displays the status of the present set mode. The set mode display flashes while the E2CD is waiting for an input. It is possible to select one of the following two modes on the E2CD.

**MODE A:** Deviation value setting mode. A standard value and its tolerance are input in this mode.

**MODE B:** Upper- and lower-limit setting mode. An upper-limit value and lower-limit value are input in this mode.

### Mode A

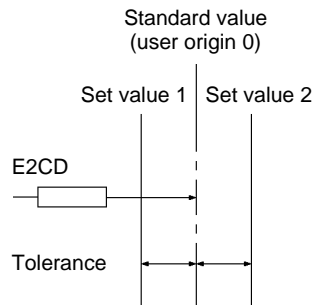

### Mode B

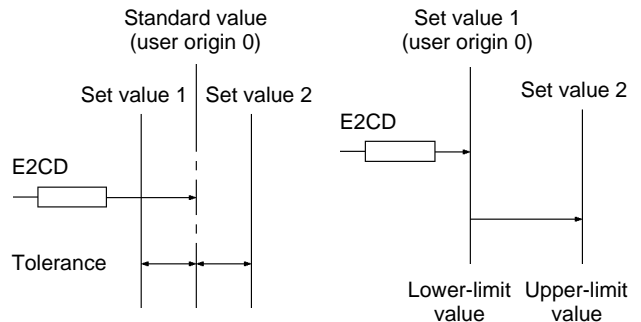

### Set Input Indicator

Displays the status of the present value display. The set input indicator flashes while the E2CD is waiting for an input.

**IN1:** The standard value is displayed in MODE A and the lower-limit value is displayed in MODE B. The IN1 input value will be the user origin in this case. Thus 0 is displayed after the IN1 value is input.

**IN2:** The tolerance is displayed in MODE A and the upper-limit value is displayed in MODE B.

### Value Indicator

The 7-segment display of 3 1/2 digits ( $\pm 1999$ ) is possible. The set input value (in the SET mode), monitor value (in the RUN mode), and an error message will be displayed. One digit is the same as the set resolution.

### Monitor (RUN Mode only)

Displays the distance between the user origin and the sensing distance.

### RUN Indicator

Indicates that the E2CD is set to the RUN mode.

# Operation

## I/O CIRCUIT DIAGRAM

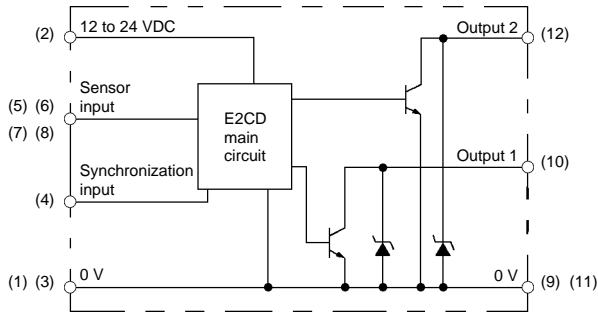

## CONNECTION

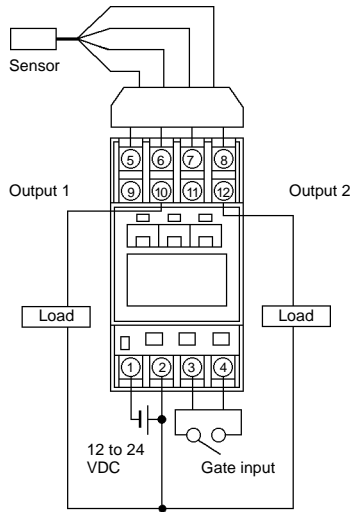

Terminal No.	Terminal type
1	Power supply 0 V
2	Power supply +V
3	Gate input 0 V
4	Gate input
5	Sensor input
6	Sensor input
7	Sensor input
8	Sensor input
9	Output 0 V
10	Output 1
11	Output 0 V
12	Output 2

## OPERATION CHART

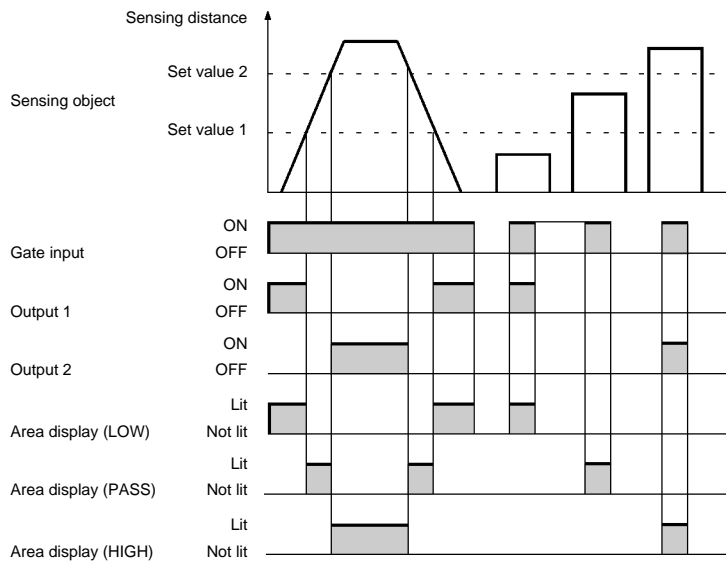



■ OPERATING PROCEDURES

Before operating an E2CD, be sure to connect the sensor head to the E2CD and provide power and a gate input to the E2CD. If the sensor head is not connected, an error (E2 error) will result. If the gate input is not provided, the zone display LED and output will be prohibited.

If no gate input is used, short-circuit the gate terminal and 0-V terminal. These terminals are short-circuited before shipping. The following flow chart shows the operating procedures of an E2CD.

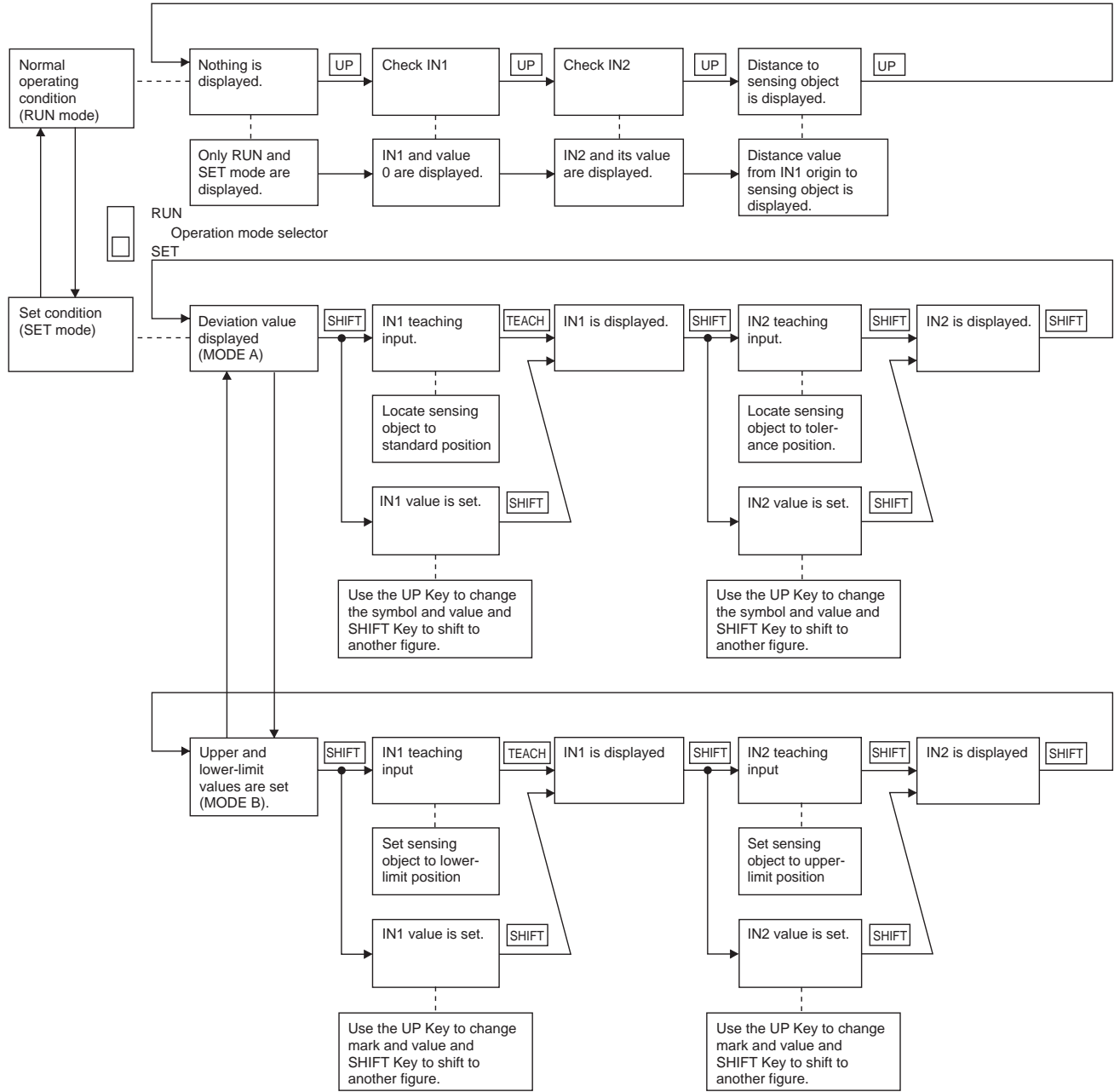

**Relationship Among Value Increment/Decrement Direction, Output, and Hysteresis**

The displayed value increases as shown in the following timing chart. The set value indicates the point where the output is turned ON.

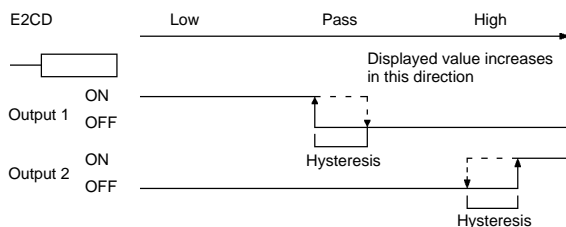

Note: Because of the hysteresis, if the difference between set values 1 and 2 are smaller than the hysteresis, a normal output is ON but the zone indicators will not operate normally.

### Relationship Among Set Mode and Input Value

#### MODE A (Deviation Value Setting)

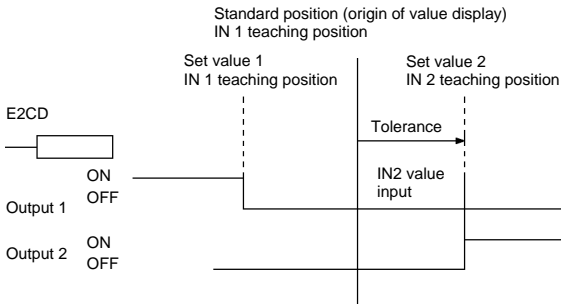

#### MODE B (Upper and Lower-limits Setting)

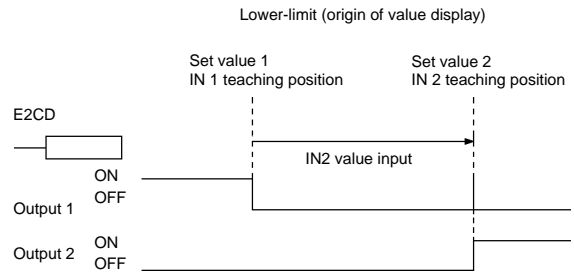

Note: When using the teaching function, the sensed object must be within the sensing range or no teaching input will be accepted by the E2CD.

### Operation Example 1: Discrimination in MODE A (Deviation Set Value Mode)

In this example, a single plate is discriminated from two plates, on condition that the difference in value between a single plate and two plates has been confirmed to be 100 by viewing the monitor display in the RUN mode (refer to example 4).

Procedure	Operation	Display	Meaning
1	Set the operation mode selector to SET.		The E2CD is ready for the mode input.
2	Select MODE A. If MODE B has been displayed, use the UP Key to change MODE B to MODE A. Then press the SHIFT Key.		MODE A has been input and the E2CD is ready for the IN1 value input.
3 Teaching input	Locate a steel plate and press the TEACH Key.		Press the TEACH Key to input the IN1 value. Do not set any symbol or value, otherwise the teaching input function cannot be used and the user must restart the operation. When the IN1 value is input, "0" will be displayed.

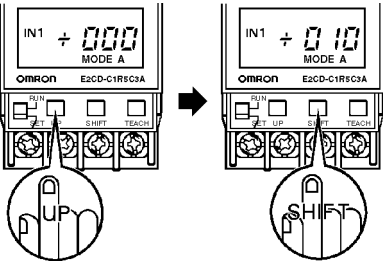
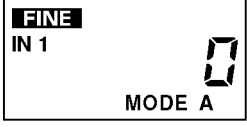
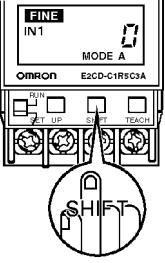
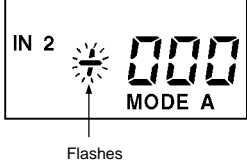
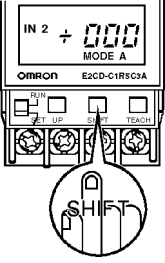
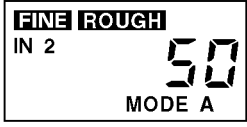
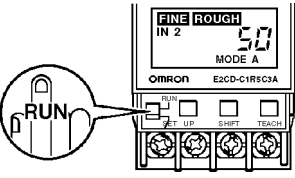
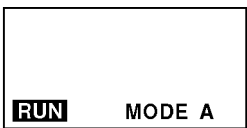
Procedure	Operation	Display	Meaning
3 (continued) Value input	Use the UP Key to set the symbol or value for each digit. Press the SHIFT Key to shift to the next digit. After all digits are set, press the SHIFT Key to input the IN1 value.  		Use the UP Key to set the value or symbol for each digit. The mark changes from + to +1, -1, -, and + in this order each time the UP Key is pressed. The value for each digit increases by increments of one each time the UP Key is pressed. When the IN1 value is input, "0" will be displayed. Use the value input function to fine-tune the E2CD.
4	Press the SHIFT Key.  		The E2CD is ready for the IN2 input.
5	Use the UP and SHIFT Keys to set IN2 to 50. After IN2 is set to 50, press the SHIFT Key to input the IN2 value.  		The difference in value between a single steel plate and two steel plates is 100. Therefore, input the mean value (50) as the IN2 value (tolerance). Then "50" is displayed. It is also possible to use the teaching input function to input the IN2 value.
6	Set the operation mode selector to RUN.  		The set value is written to the non-volatile memory and the E2CD operates. In this mode, the set value cannot be changed. To change the set value, press the SHIFT Key before setting the operation mode selector to RUN. Then the E2CD will be ready for the mode input (refer to step 1).



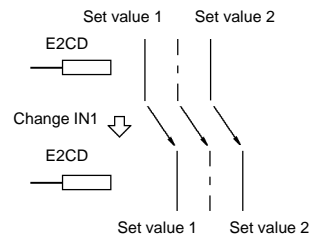

Note: 1. When the IN1 value that has been set is changed in MODE A, set values 1 and 2 will shift according to the difference between the old and new IN1 values.  
 Set value 1 or 2 = Standard value ± tolerance.  
 New set value 1 or 2 = New standard value ± tolerance.  
 2. The contents of the set value zone indicators (FINE, ROUGH, NG) vary with the set status.

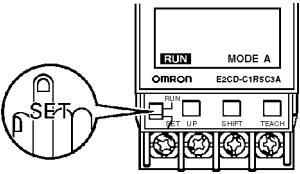
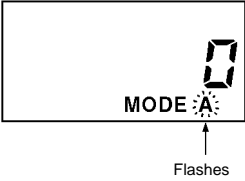
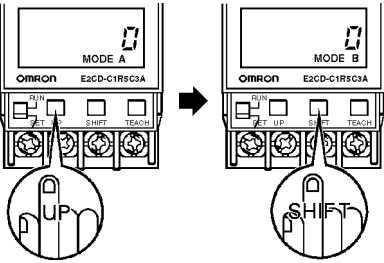
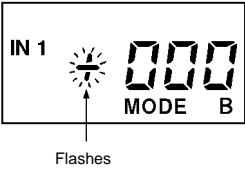
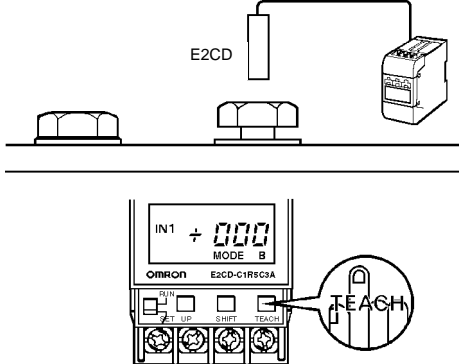
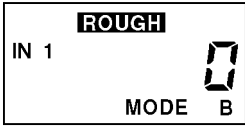
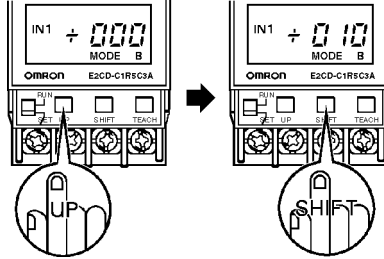
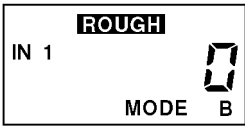

**Operation Example 2: In MODE B (Upper and Low-limits Setting Mode)**

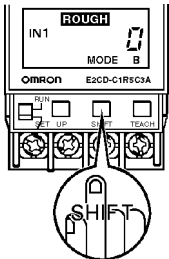
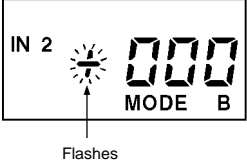
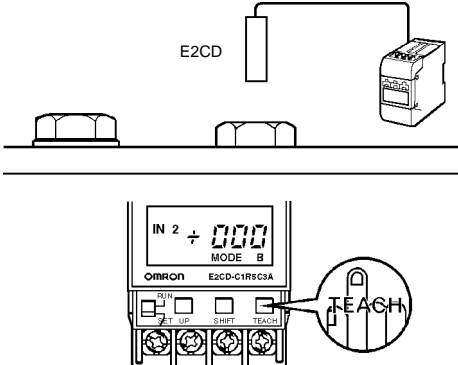
In this example, the tightness of each bolt with or without a washer is checked. Prepare sample of a bolt tightened loose and another sample of a bolt without a washer both on the threshold of being sensed.

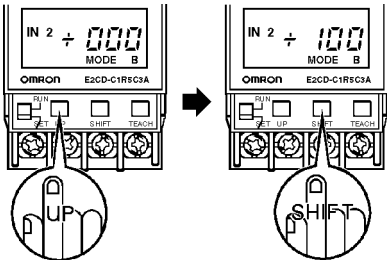



Procedure	Operation	Display	Meaning
1	Set the operation mode selector to SET. 		The E2CD is ready for the mode input.
2	Select MODE B. If MODE A has been displayed, use the UP Key to change MODE A to MODE B. Then press the SHIFT Key. 		MODE B has been input and the E2CD is ready for the IN1 value input.
3 Teaching input	Locate the loose sample bolt as shown in the following illustration and press the TEACH Key. 		Press the TEACH Key to input the IN1 value. Do not set any symbol or value, otherwise the teaching input function cannot be used and the user must restart the operation. When the IN1 value is input, "0" will be displayed.
Value input	Use the UP Key to set the symbol or value for each digit. Press the SHIFT Key to shift to the next digit. After all digits are set, press the SHIFT Key to input the IN1 value. 		Use the UP Key to set the value or symbol for each digit. The symbol changes from + to +1, -1, and + in this order each time the UP Key is pressed. The value for each digit increases by increments of one each time the UP Key is pressed. When the IN1 value is input, "0" will be displayed. Use the value input function to fine-tune the E2CD.

Procedure	Operation	Display	Meaning
4	<p>Press the SHIFT Key.</p> 	 <p>Flashes</p>	<p>The E2CD is ready for the IN2 input.</p>
5 Teaching input	<p>Locate the sample bolt without a washer as shown in the following illustration and press the TEACH Key.</p> 		<p>The IN2 value will be input when the TEACH Key is pressed, at which time the IN2 value based on IN1 as the origin will be displayed.</p>
Value input	<p>Use the UP Key to change the IN2 value. Press the SHIFT Key to shift to the next digit. After the IN2 value is decided, press the SHIFT Key to input it.</p> 		<p>Input the IN2 value for fine-tuning.</p>

### Operation Example 3: Positioning

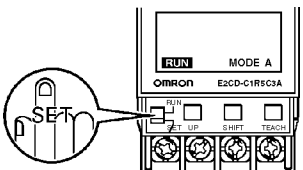
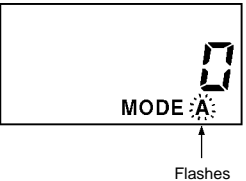
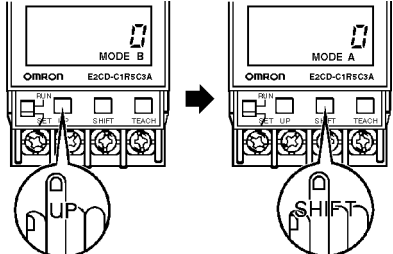
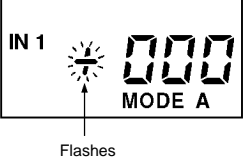
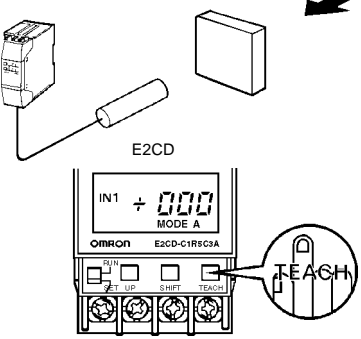
In this example, the E2CD has an output when a sensing object is located at the position that has been specified. There are two ways to specify the position.

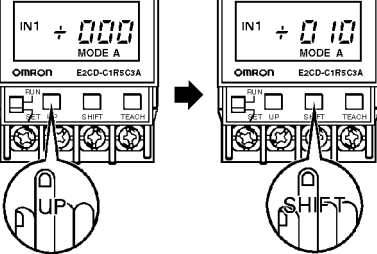
One method is to specify the point to be IN1 MODE A (Deviation Set Value Mode) and let the tolerance (IN2) be 0. The other method is to specify the point to be the lower-limit value (any upper-limit value can be set), in which case output 1 is used. The first method is explained below.



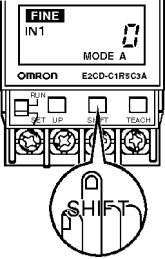
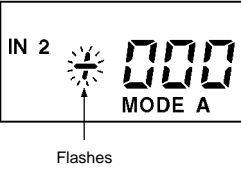
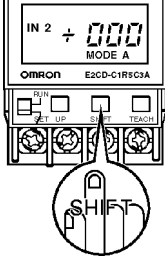
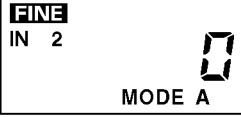
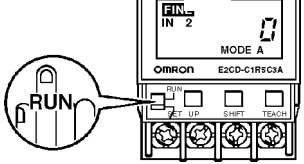
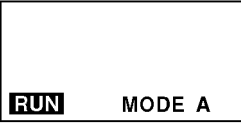

Procedure	Operation	Display	Meaning
1	Set the operation mode selector to SET. 		The E2CD is ready for the mode input.
2	Select MODE A. If MODE B has been displayed, use the UP Key to change MODE B to MODE A. Then press the SHIFT Key. 		MODE A has been input and the E2CD is ready for the IN1 value input.
3 Teaching input	Locate a sensing object to the sensing position and press the TEACH Key. 		Press the TEACH Key to input the IN1 value. Do not set any symbol or value, otherwise the teaching input function cannot be used and the user must restart the operation. When the IN1 value is input, "0" will be displayed.
Value input	Use the UP Key to set the symbol or value for each digit. Press the SHIFT Key to shift to the next digit. After all digits are set, press the SHIFT Key to input the IN1 value. 		Use the UP Key to set the value or symbol for each digit. The symbol changes from + to +1, -1, -, and + in this order each time the UP Key is pressed. The value for each digit increases by increments of one each time the UP Key is pressed. When the IN1 value is input, 0 will be displayed. Use the value input function to fine-tune the E2CD.

Procedure	Operation	Display	Meaning
4	Press the SHIFT Key. 		The E2CD is ready for the IN2 input.
5	Press the SHIFT Key four times. 		The tolerance (0) is input and "0" is displayed.
6	Set the operation mode selector to RUN. 		The set value is written to the non-volatile memory and the E2CD operates. In this mode, the set value cannot be changed. To change the set value, press the SHIFT Key before setting the operation mode selector to RUN. Then the E2CD will be ready for the mode input (refer to step 1).

Note: 1. The contents of the set value zone indicators (FINE, ROUGH, NG) vary with the set status.

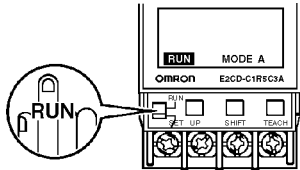
### Operation Example 4: Displaying in RUN Mode

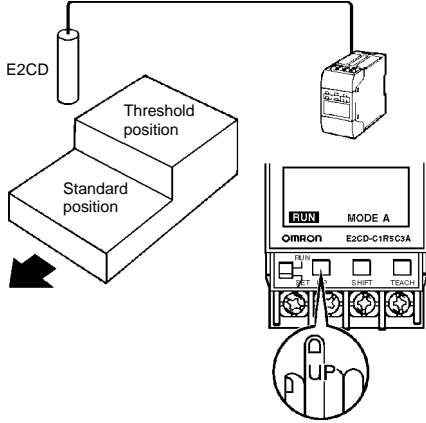
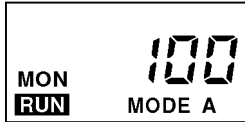
It is possible to check the IN1 and IN2 values or monitor the distance between the sensor and the sensing object in order to use the distance value as a reference value for setting the set value.

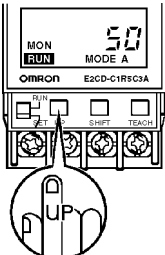
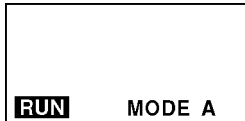
Procedure	Operation	Display	Meaning
1	Set the operation mode selector to RUN (so that the E2CD will work normally). 		The initial screen indicates the RUN mode and the present set mode.
2	Locate the E2CD and a sensing object (a threshold sample) to the specified positions. If required, locate a synchronization sensor. Press the UP Key three times. 		Monitors the distance between the sensor and the sensing object and displays the distance. The origin of the value display is set to the center of the sensing range before shipment. It will be at the IN1 input position after user setting.
3	Adjust the position of the E2CD so that the standard position of the sensing object will be in the center of the sensing range. Then fix the position of the E2CD.		The E2CD detects an object most accurately in the center of the sensing range.
4	Detect the threshold position of the sensing object with the E2CD.		The difference between the displayed value and standard position will be the tolerance (IN2).
5	Press the UP Key. 		Returns to the initial screen.

Note: A monitor value is effective only when the synchronization input is ON. If the synchronization input is OFF, the previous value will be put on hold.



# Installation

## E2CD-□ (Cylindrical Type without Threads)

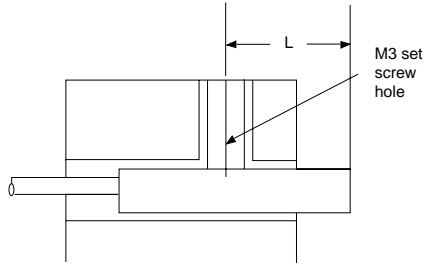

When using a set screw, the tightening torque of the set screw must be 2 kgf • cm (1.73 in • lbs) maximum. Refer to the following table for the L ranges of the respective models.

Part number	L
<b>E2CD-C1C3A</b>	10 to 23 mm (0.39 to 0.91 in)
<b>E2CD-C1R5C3A</b>	12 to 30 mm (0.47 to 1.18 in)

## E2CD-X□ (Cylindrical Type with Threads)

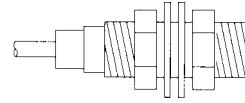

Refer to the following table for the tightening torque ranges of the nuts of the respective models. Be sure to tighten each nut coupled with a toothed washer.

Part number	L
<b>E2CD-X2R5C3A</b>	100 kgf • cm (86.6 in • lbs)
<b>E2CD-X5C3A</b>	200 kgf • cm (173.2 in • lbs)

Note: Apply the above tightening torque to each nut coupled with a washer.

### ■ EFFECTS OF SURROUNDING METAL

When mounting the E2CD within a metal panel, ensure that the clearances given in the following table are maintained. Failure to maintain these distances may cause deterioration in the performance of the sensor.

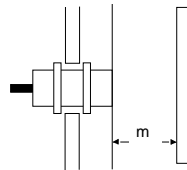

Part number	m
<b>E2CD-C1C3A</b>	3 mm (0.12 in)
<b>E2CD-C1R5C3A</b>	4.5 mm (0.18 in)
<b>E2CD-X2R5C3A</b>	6 mm (0.24 in)
<b>E2CD-X5C3A</b>	15 mm (0.59 in)

### ■ MUTUAL INTERFERENCE

When installing two or more E2CD face to face or side by side, ensure that the minimum distances given in the following table are maintained.

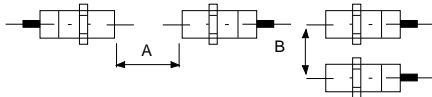

Part number	A	B
<b>E2CD-C1C3A</b>	20 mm (0.79 in)	15 mm (0.59 in)
<b>E2CD-C1R5C3A</b>	20 mm (0.79 in)	15 mm (0.59 in)
<b>E2CD-X2R5C3A</b>	30 mm (1.18 in)	20 mm (0.79 in)
<b>E2CD-X5C3A</b>	30 mm (1.18 in)	30 mm (1.18 in)

# Precautions

---

## Compatibility

Use the appropriate combination of E2CD sensor and amplifier. Both units should bear the same identification number. The identification number appears on the sensor cable plug and on the side panel of the amplifier.

## Truncating or Extending the Sensor Cable

Do not attempt to cut or extend the length of the sensor cable. The E2CD sensor is precisely calibrated at our factory for mating with its amplifier. Changing the sensor cable length will change the characteristics and Omron will no longer guarantee the specifications of its operation.

## Environmental Changes

The sensor should not be exposed to sudden and dramatic temperature changes. Also, do not subject the sensor to high physical stress.

## Initialization

Upon applying electrical power, the E2CD system automatically performs a diagnostic check of its internal circuitry. This procedure takes approximately 8 seconds. Normal operation will resume after this initial warm-up period. The system will not require additional warming up as long as power is continuously supplied.

**NOTE: DIMENSIONS ARE IN MILLIMETERS. To convert millimeters to inches divide by 25.4.**

---

# OMRON

Omron Europe B.V. EMA-ISD, tel:+31 23 5681390, fax:+31 23 5681397, <http://www.eu.omron.com/ema>