

Ideal for Stepping Motor Tripping  
Detection and Position Control of  
Loaders or Unloaders

- No need to reset origin point at power-up
- IP50 certification
- Ideal for packaging, plastics, electronics assembly, robotic and semiconductor applications
- Measures rotations and retains data after a power interruption
- Compact encoder head (45 mm diameter x 50 mm length)
- Hollow-shaft model absorbs the vibration of a driving axis



## Ordering Information

### ■ ABSOLUTE ROTARY ENCODERS

Item	Part number
Shaft model with cable	E6C-NN5C
Hollow-shaft model with cable	E6C-NN5CA
Shaft model with connector	E6C-NN5C-C
Hollow-shaft model with connector	E6C-NN5CA-C

### ■ ACCESSORIES (ORDER SEPARATELY)

Item	Remarks	Part number
Coupling	---	E69-C06B
Coupling	Metal construction	E69-C06M
Flange	---	E69-FCA
Flange	---	E69-FCA-02
Mounting Bracket	Provided with E69-FCA02 Flange	E69-2

# Specifications

## ■ RATINGS/CHARACTERISTICS

Power supply voltage		12 VDC <sup>-10%</sup> to 24 VDC <sup>+10%</sup> , ripple (p-p): 5% max. (see note 1)
Current consumption		80 mA max.
Resolution	Single-rotation absolute	500 P/R
	Multi-rotation absolute	-128 to 127 rotations (see note 6)
Rotational limitation at power failure		±80° (see note 2)
Output	Output code	Binary code
	Alarm output	Counter Overflow Output (see note 3)
	Output configuration	NPN open-collector output
	Output capacity	Applied voltage: 30 VDC max. I <sub>sink</sub> : 10 mA max. (with 30-mA Counter Overflow Output) Residual voltage: 0.4 V max.
	Logic	Negative logic output
	Rotational direction	Clockwise, as viewed from the face of the shaft.
Input	Input signal	Single-rotation data reset and multi-rotation data reset (see note 4)
	Input current	1 mA max.
	Input logic	L active, normally open
	Input time	100 ms max.
Max. response frequency		12.5 kHz
Rise and fall times of output		1 μs max.
Starting torque		30 gf • cm (2.94 mN • m) (2.17 m ft • lbf) max.
Moment of inertia		1.5 x 10 <sup>-6</sup> kg • m <sup>2</sup> (15 g • cm <sup>2</sup> ) (0.21 lb/in <sup>2</sup> ) max.
Shaft loading	Radial	3 kgf (29.4N) (6.6 lbf)
	Thrust	2 kgf (19.6N) (4.4 lbf)
Max. permissible rotation		1,500 rpm
Ambient temperature	Operating	-10°C to 55°C (14°F to 131°F) with no icing (see note 5)
	Storage	-25°C to 65°C (-13°F to 149°F)
Ambient humidity		35% to 85% with no condensation
Insulation resistance		20 MΩ min. (at 100 VDC) between carry parts and case
Dielectric strength		500 VAC, 50/60 Hz for 1 min between carry parts and case
Vibration resistance		Destruction: 10 to 500 Hz, 1.0-mm single amplitude or 150 m/s <sup>2</sup> (15G) for 11 min, 3 times each in X, Y, and Z directions
Shock resistance		Destruction: 1,000 m/s <sup>2</sup> (100G) 3 times each in X, Y, and Z directions
Enclosure rating		IEC IP50
Housing material	Mechanism	PPS resin
	Case	ABS resin
Weight		400 g max. (with 2-m cable)

- Note: 1. When the power supply is turned off, all data output is turned off and no data can be input.
2. At the time of power failure, no multi-rotation detection is performed, and multi-rotation data is compensated by comparing the data values immediately before and after the power fails. The accuracy of multi-rotation data will be affected if the power fails and there is a rotation exceeding ±80° of the position at the time of power failure. Be sure that the rotation is within the specified range.
3. Counter Overflow Output will turn ON if the multi-rotation counter exceeds a range between -128 and 127 rotations. This error flag will be reset if the count returns to a value within the above range.
4. If single- and multi-rotation data reset signals are input, single-rotation data will be reset to address 0 and independently, multi-rotation data will be reset to rotation 0.
5. Be sure that the equipment connected to the Encoder shaft is within the rated operating range.

(Table notes continued on the next page)

6. Multi-rotation absolute negative values are expressed with 2's complements. Refer to the list of codes provided.

#### Multi-rotation Absolute Value Codes

Note that by replacing values 1 and 0 of a positive value with each other and adding 1, a negative value is expressed.

Multi-rotation absolute value	Code
10	00001010
9	00001001
8	00001000
7	00000111
6	00000110
5	00000101
4	00000100
3	00000011
2	00000010
1	00000001
0	00000000
-1	11111111
-2	11111110
-3	11111101
-4	11111100
-5	11111011
-6	11111010
-7	11111001
-8	11111000
-9	11110111
-10	11110110
-11	11110101

## Operation

### ■ CONNECTION

#### E6C-NN5C□ - Cable Specifications

Cable color: Gray			Cable color: Black				
Lead wire color	Signal name	Description	Lead wire color	Signal name	Description		
Brown	ABS0	Single-rotation absolute data	2 <sup>0</sup>	Brown	TKN0	Multi-rotation absolute data	2 <sup>0</sup>
Orange	ABS1		2 <sup>1</sup>	Orange	TKN1		2 <sup>1</sup>
Yellow	ABS2		2 <sup>2</sup>	Yellow	TKN2		2 <sup>2</sup>
Green	ABS3		2 <sup>3</sup>	Green	TKN3		2 <sup>3</sup>
Blue	ABS4		2 <sup>4</sup>	Blue	TKN4		2 <sup>4</sup>
Purple	ABS5		2 <sup>5</sup>	Purple	TKN5		2 <sup>5</sup>
Gray	ABS6		2 <sup>6</sup>	Gray	TKN6		2 <sup>6</sup>
White	ABS7		2 <sup>7</sup>	White	TKN7		2 <sup>7</sup>
Pink	ABS8		2 <sup>8</sup>	Pink	C0F		Counter overflow alarm
Light blue	ARST	Single-rotation data reset	Light blue	TRST	Multi-rotation data reset		
Black	GND	0 V (see note)	Black	GND	0 V (see note)		
Red	V <sub>CC</sub>	12 to 24 VDC (see note)	Red	V <sub>CC</sub>	12 to 24 VDC (see note)		
---	SHIELD	Shield	---	SHIELD	Shield		

Note: It is recommended that both V<sub>CC</sub> lines and GND lines be connected.

**E6C-NN5C□ - C Connector Specifications**

Cable color: Gray				Cable color: Black			
Pin	Signal name	Description		Pin	Signal name	Description	
A1	ABS0	Single-rotation absolute data	2 <sup>0</sup>	B1	TKN0	Multi-rotation absolute data	2 <sup>0</sup>
A2	ABS1		2 <sup>1</sup>	B2	TKN1		2 <sup>1</sup>
A3	ABS2		2 <sup>2</sup>	B3	TKN2		2 <sup>2</sup>
A4	ABS3		2 <sup>3</sup>	B4	TKN3		2 <sup>3</sup>
A5	ABS4		2 <sup>4</sup>	B5	TKN4		2 <sup>4</sup>
A6	ABS5		2 <sup>5</sup>	B6	TKN5		2 <sup>5</sup>
A7	ABS6		2 <sup>6</sup>	B7	TKN6		2 <sup>6</sup>
A8	ABS7		2 <sup>7</sup>	B8	TKN7		2 <sup>7</sup>
A9	ABS8		2 <sup>8</sup>	B9	C0F	Counter overflow alarm	
A10	ARST	Single-rotation data reset		B10	TRST	Multi-rotation data reset	
A11	GND	0 V (see note)		B11	GND	0 V (see note)	
A12	V <sub>CC</sub>	12 to 24 VDC (see note)		B12	V <sub>CC</sub>	12 to 24 VDC (see note)	
A13	SHIELD	Shield		B13	SHIELD	Shield	

Note: It is recommended that both V<sub>CC</sub> lines and GND lines be connected.

**Terminal Arrangement**

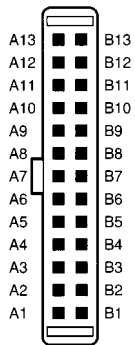

**INPUT CIRCUIT DIAGRAM**

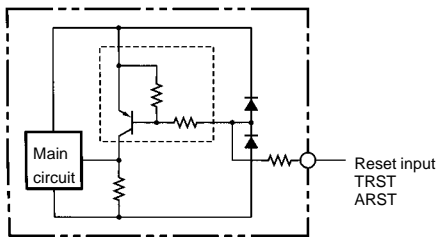

**OUTPUT CIRCUIT DIAGRAM**

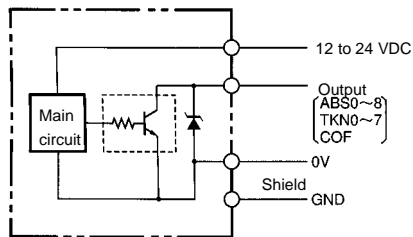

Note: The output of each bit shares the same circuit.

## OUTPUT MODE

Rotational Direction: Clockwise, as viewed from the face of the shaft.

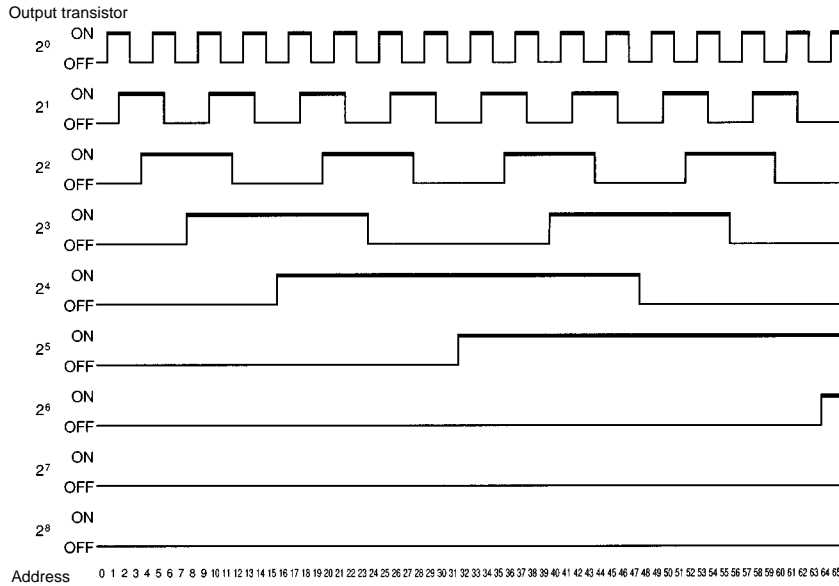

## ORIGIN RESET ENSURES EASY ORIGIN SETTING AFTER ENCLOSED MOUNTING

In addition to the conventional reset function for multi-rotation data, a reset function for single-rotation data is available. This feature ensures easy origin setting of the E6C-N after enclosed mounting and saves the number of steps required for the reset operation.



## DATA STORED WITH NO BACKUP POWER SUPPLY

Multi-rotation data is stored in the non-volatile built-in memory at the time of power failure, eliminating the need for a conventional backup power supply and simplifying the system configuration. Multi-rotation detection is, however, not possible at the time of power failure, and multi-rotation data is compensated according to the rotational operation within  $\pm 80^\circ$  of the position at the time of power failure.

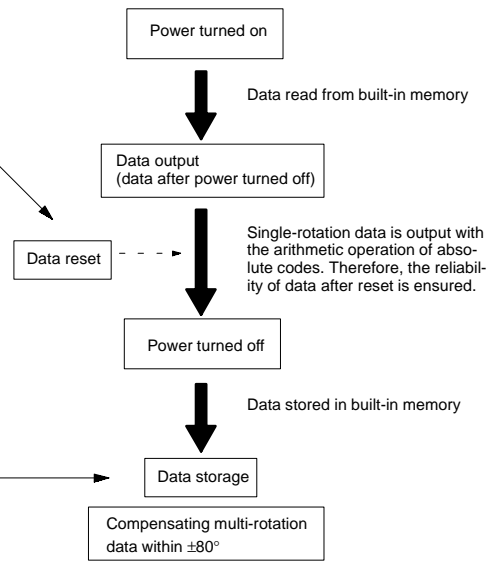
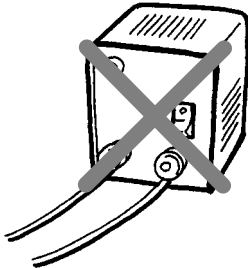

Note: Data: Single-rotation, Multi-rotation data

# Dimensions

Unit: mm (inch)

## ■ E6C-NN5C (WITH CABLE) E6C-NN5C-C (WITH CONNECTOR)

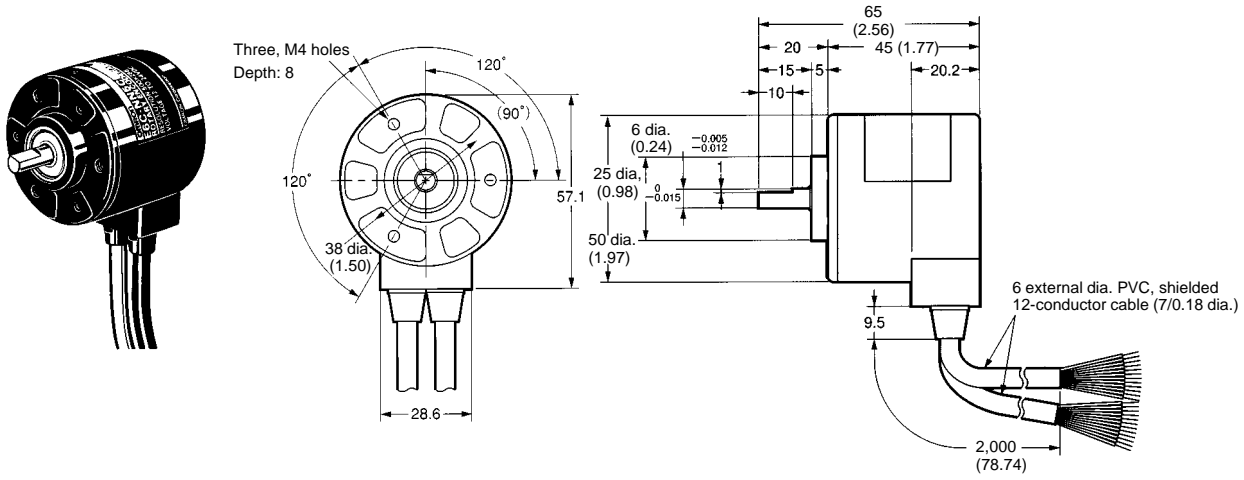

E6C-NN5C-C

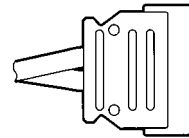

## ■ E6C-NN5CA (WITH CABLE) E6C-NN5CA-C (WITH CONNECTOR)

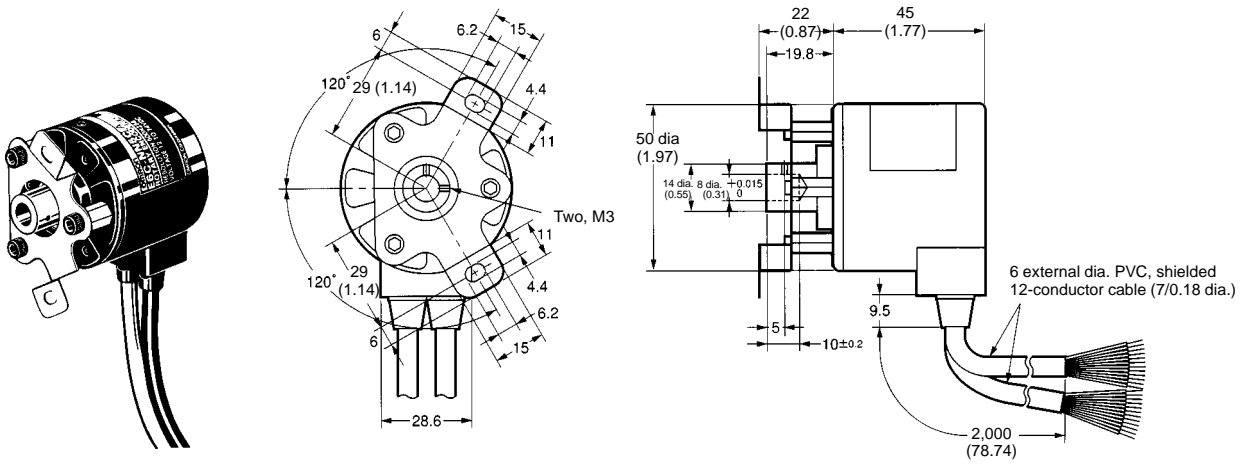

E6C-NN5CA-C

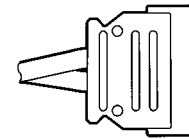

### Mounting Dimensions

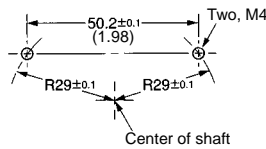

Unit: mm (inch)

■ ACCESSORIES (ORDER SEPARATELY)

Couplings

E69C-C06B

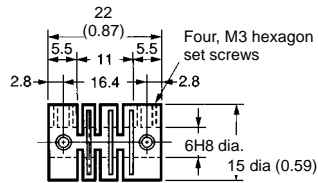

Note: Material is glass-reinforced PBT

E69-C06M (Metal Construction)

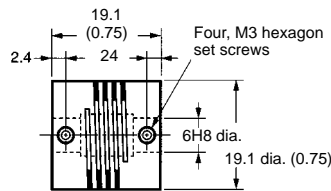

Note: Material is super duralumin

Flanges

E69-FCA

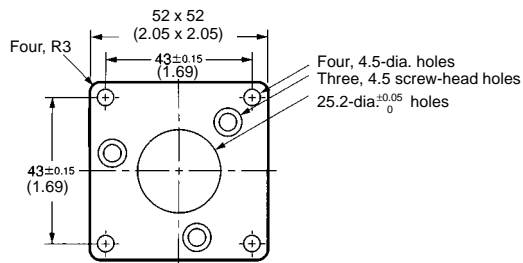

Note: Material is SPCC, t = 3.2

E69-FCA-02

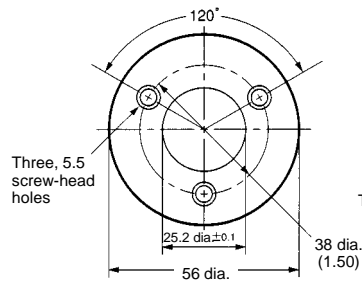

Note: Material is SPCC, t=3.2

Mounting Bracket:  
(A set of three Brackets provided with the E69-FCA-02)

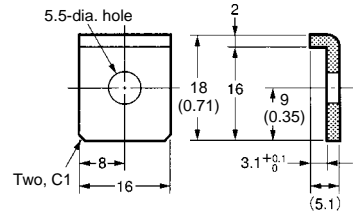

Mounting Dimensions

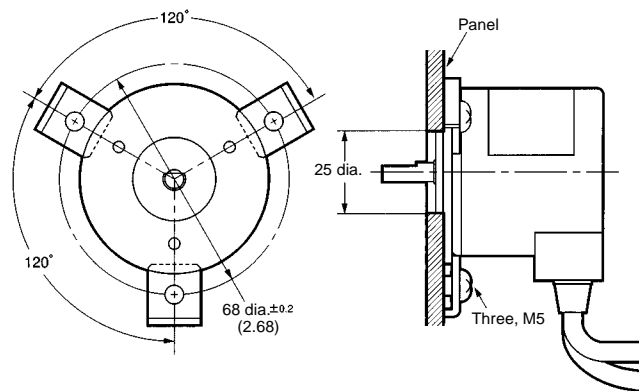

Servo Mounting Bracket

E69-2 (Set of three)

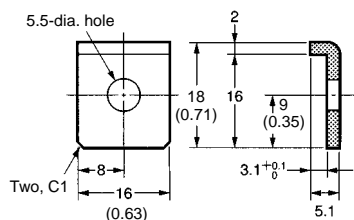

Note: A set of E69-2 Servo Mounting Brackets is provided with the E69-FCA-02 Flange.

# Installation

## CONNECTION EXAMPLE

### Connection with CPM1A

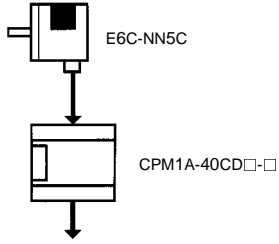

### Wiring between E6C-NN5C and CPM1A

E6C-NN5C output signal		CPM1A input signal	
Single-rotation data	Cable cover color (gray)	Brown (2 <sup>0</sup> )	00000
		Orange (2 <sup>1</sup> )	00001
		Yellow (2 <sup>2</sup> )	00002
		Green (2 <sup>3</sup> )	00003
		Blue (2 <sup>4</sup> )	00004
		Purple (2 <sup>5</sup> )	00005
		Gray (2 <sup>6</sup> )	00006
		White (2 <sup>7</sup> )	00007
		Pink (2 <sup>8</sup> )	00008
Multi-rotation data	Cable cover color (black)	Brown (2 <sup>0</sup> )	00100
		Orange (2 <sup>1</sup> )	00101
		Yellow (2 <sup>2</sup> )	00102
		Green (2 <sup>3</sup> )	00103
		Blue (2 <sup>4</sup> )	00104
		Purple (2 <sup>5</sup> )	00105
		Gray (2 <sup>6</sup> )	00106
		White (2 <sup>7</sup> )	00107
		Code + = 0 - = 1	

### Output Timing

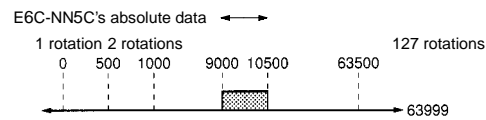

### DM Setting

DM 0000		Data program work area	
0001			
0002	0000		
0003			
0004			
0005			
0006			
0007			Linear absolute data
0008			
0009			Comparison data
0010	9000		
0011	0000		Upper-limit setting
0012	0500		
0013	0001	Lower-limit setting	

### Ladder Program Example

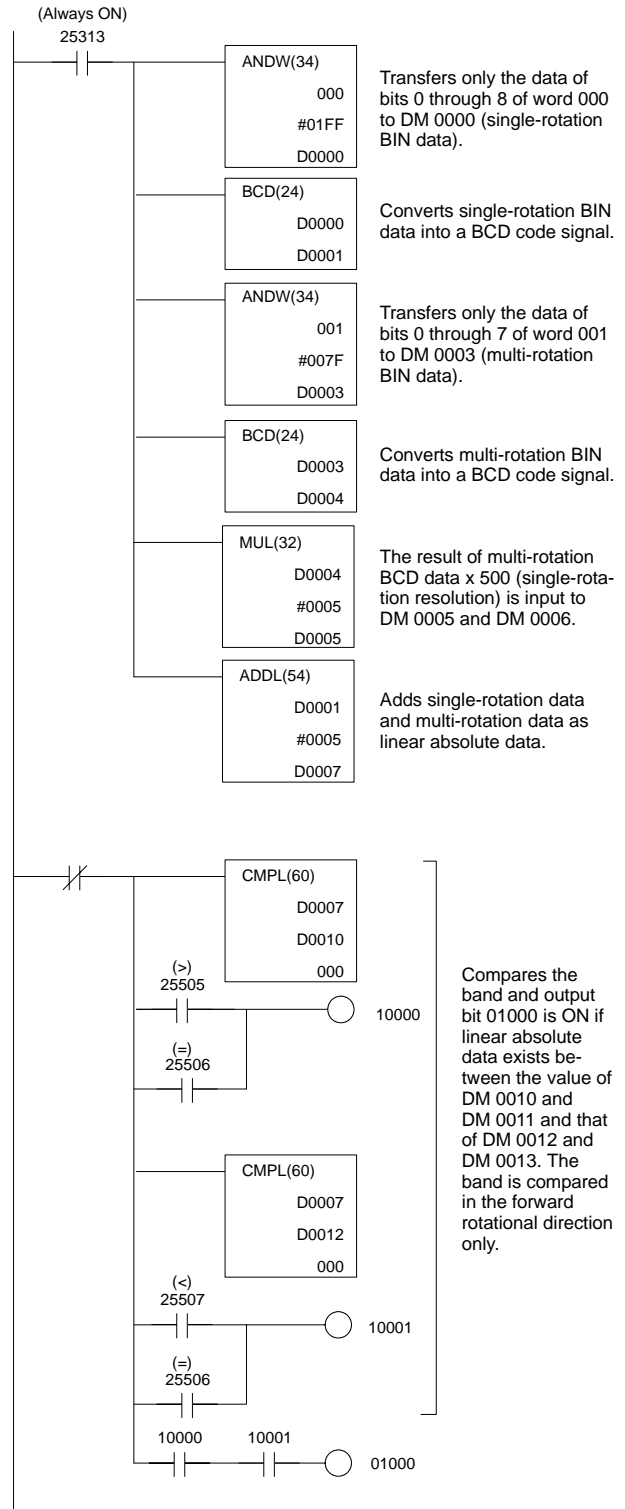



## Precautions

---

### ■ MOUNTING

#### To Avoid Damage or Malfunction

- Do not use the E6C-N at a voltage exceeding the rated voltage range.
- Be sure to wire the lines of the E6C-N separately from power lines-tension lines in a separate, shielded conduit.
- Do not make mistakes in wiring, such as mistakes in polarity.
- Be sure that the E6C-N is turned off when wiring, or the output circuit may be damaged if an active output line comes in contact with the power line.

### ■ CORRECT USE

- If the power supply has surge voltage, connect a surge absorber in parallel to the power supply to absorb the surge voltage.
- To protect the E6C-N from noise interference, be sure that each wire connected to the E6C-N is as short as possible.
- The E6C-N may output a pulse signal when the E6C-N is turned on or off. Turn on each device connected to the E6C-N one second after turning on the E6C-N and turn each device off one second before turning off the E6C-N.

The E6C-N consists of high-precision components. Handle the E6C-N with care:

- Keep E6C-N free of water or oil drops.
- Do not short-circuit the load, or the E6C-N may be damaged.
- If the E6C-N is mounted with a cable wired, do not pull the cable with a force exceeding 3 kgf (29.4 N).
- The torque required to tighten each screw must be 5 kgf • cm (0.49 N • m) maximum. Excessive tightening torque may damage the E6C-N.
- Do not impose excessive loads on the shaft, or the shaft may be damaged.
- Do not directly connect the shaft to chains, timing belts, or gears. Be sure to connect the shaft through appropriate bearings and couplings.
- If there is a difference in angle between the shaft and the other shaft connected, an excessive load that may damage the shaft will be imposed on the shaft. Be sure that the shaft is connected properly.
- When inserting the shaft to a coupling, do not strike the shaft or coupling with a hammer or impose any other shock to the shaft or coupling.
- When connecting or disconnecting the coupling to or from the shaft, do not excessively bend, press, or pull the coupling.

**NOTE: DIMENSIONS SHOWN ARE IN MILLIMETERS. To convert millimetres to inches divide by 25.4.**

---

**OMRON**<sup>®</sup>

Omron Europe B.V. EMA-ISD, tel:+31 23 5681390, fax:+31 23 5681397, <http://www.eu.omron.com/ema>