

Buffer Block

S8T-DCBU-02

Prevents Equipment Stoppage, Data Loss, and Other Problems Resulting from Momentary Power Failures

- Provides a backup time of 500 ms at an output current of 2.5 A.
- Can be wired to the 24-V output from the S8VS, S8VM, S82J, S82K, and S8PS Power Supplies.
- Connects to an S8TS Power Supply via an S8T-BUS03 Bus Line Connector.
- Parallel connections to up to four Blocks can be used to increase the backup time and current capacities.
- Complies with SEMI F47-0200 standard.
- RoHS-compliant

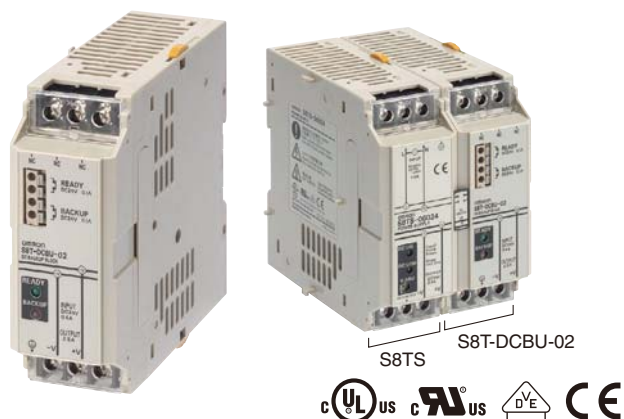

Note: Refer to *Safety Precautions* on page 16.

Ordering Information

■ Buffer Block

Input voltage	Output voltage (during backup operation)	Output current	Model number
24 VDC (24 to 28 VDC)	22.5 V	2.5 A	S8T-DCBU-02

■ Options (Order Separately)

Bus Line Connector (Connects to Buffer Block)

Type	Number of Connectors	Model number
Connector with DC line connected.	1 Connector	S8T-BUS03
	10 Connectors (See note.)	S8T-BUS13

Note: One package contains 10 S8T-BUS03 Connectors.

Basic Configuration

Connecting to the S8TS-06024

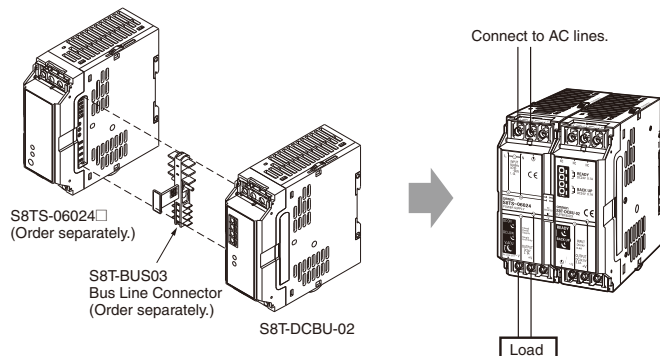

Connection via Wiring

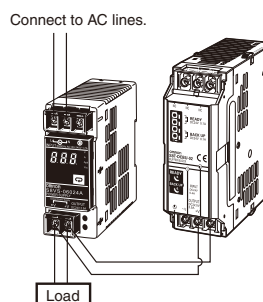

Specifications

■ Ratings/Characteristics

Item	Model	S8T-DCBU-02		
Input	Voltage	24 to 28 VDC		
	Current	Charging	0.4 A	
		Standby	0.18 A	
Output (See note 1.)	Backup operation	Output voltage	For 24 V: 22.5 V typ., 22.0 V min. For 28 V: 26.4 V typ., 25.8 V min.	
		Output current	2.5 A	
	Backup time (See note 2.)	Time required until the voltage drops from the fully charged level down to 21.6 VDC 1,000 ms min. (for an output current of 1.2 A) 500 ms min. (for an output current of 2.5 A)		
Additional functions (See note 3.)	Output functions	READY indicator	Yes (color: green)	
		READY output	Yes (relay: 24 VDC, 0.1 A max.)	
		Backup indicator	Yes (color: red)	
		Backup output	Yes (relay: 24 VDC, 0.1 A max.)	
	Overcurrent protection		Reverse-L dropping, automatic reset, overcurrent detection point: 5.8 to 6.8 A	
	Overvoltage protection		Yes	
	Parallel operation		Yes (Up to 4 Blocks)	
	Series operation		No	
Other	Ambient operating temperature		Refer to the derating curve in <i>Engineering Data</i> . (with no condensation or icing)	
	Storage temperature		-25 to 65°C	
	Ambient humidity		Operating: 25% to 85%; Storage: 25% to 90%	
	Dielectric strength (See note 4.)		1.0 kVAC for 1 minute (between all DC connection terminals and PE terminals; Detection current: 20 mA) 500 VAC for 1 minute (between all DC connection terminals/PE terminals and all signal output terminals; detection current: 20 mA)	
	Insulation resistance		100 MΩ min. (between all DC connection terminals and PE terminals) at 500 VDC	
	Vibration resistance (See notes 5 and 6.)		10 to 55 Hz, 0.375-mm single amplitude for 2 h each in X, Y, and Z directions	
	Shock resistance (See notes 5 and 6.)		150 m/s ² , 3 times each in ±X, ±Y, and ±Z directions	
	EMI	Conducted Emission (See note 5.)	Conforms to EN61204-3 EN55011 Class B and based on FCC Class A	
		Radiated Emission	Conforms to EN61204-3 EN55011 Class B	
	EMS		Conforms to EN61204-3 High severity levels	
	Approved standards	UL:	UL508 (Listing; Class 2: Per UL1310) (See note 7.), UL60950-1, UL1604 (Listing; Class I/Division 2, Group A, B, C, D Hazardous Locations)	
		cUL:	CSA C22.2 No.14 (Class 2: Per No. 223) (See note 7.), No. 213 (Class I/Division 2, Group A, B, C, D Hazardous Locations)	
		cUR:	CSA No. 60950-1	
EN/VDE:		EN50178 (= VDE0160), EN60950-1 (= VDE0805 Teil 1)		
SEMI		SEMI F47-0200		
Weight		450 g max.		

- Note:**
- The output characteristics are specified at the power output terminals.
 - Refer to *Backup Time* on page 10 for details.
 - Refer to *Functions* on page 7 for details.
 - If the number of S8T-DCBU-02 Buffer Blocks to be connected is "N," set the detection current to 20 mA × N.
 - Specified by S8TS-06024□ connection.
 - Be sure to mount an End Plate (PFP-M: Order separately) on each end of the Buffer Block. Refer to *DIN Rails* on page 15.
 - To comply with Class 2, connect one S8TS-06024□ to one S8T-DCBU-02 Buffer Block.

■ Reference Value

Item	Value	Definition
Reliability (MTBF)	135,000 hrs min.	MTBF stands for Mean Time Between Failures, which is calculated according to the probability of accidental device failures, and indicates reliability of devices. Therefore, it does not necessarily represent a life of the product.
Life expectancy	10 yrs. min.	The life expectancy indicates average operating hours under the ambient temperature of 40°C and a load rate of 50%. Normally this is determined by the life expectancy of the built-in aluminum electrolytic capacitor.

Connections

Block Diagram

S8T-DCBU-02

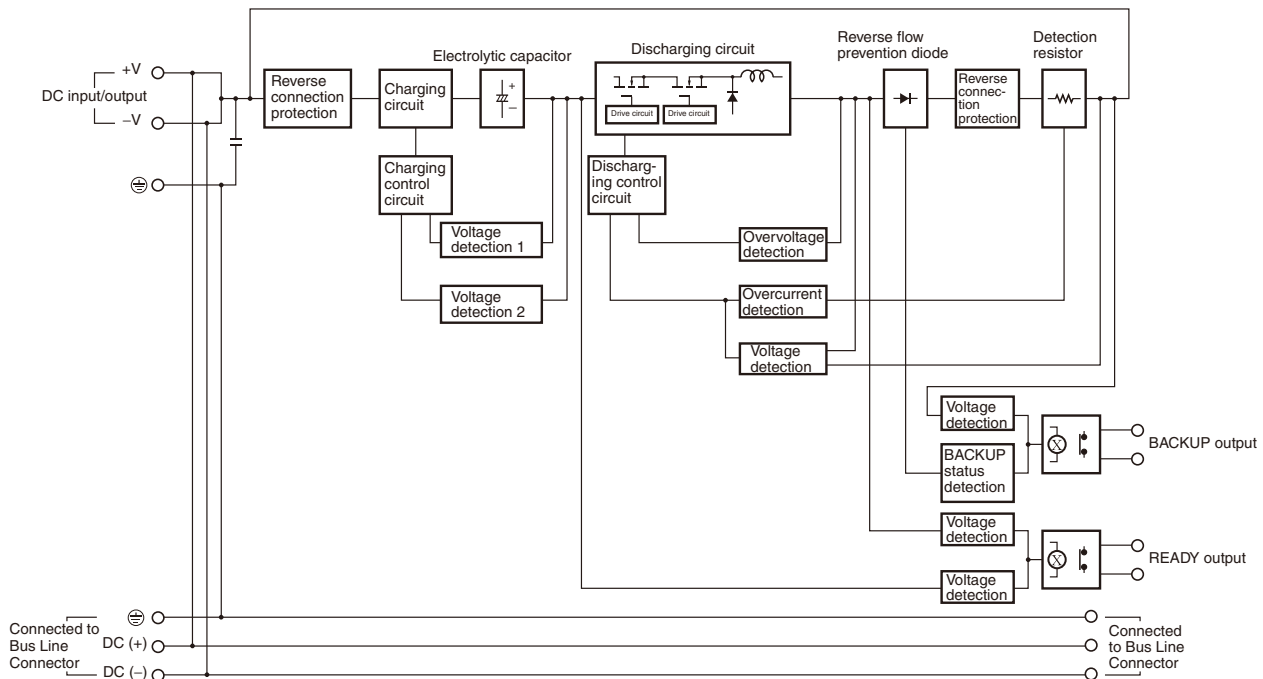

Operation

Application

Connectable Power Supplies

The following Power Supplies can be connected. When connected to the following Power Supplies, the Buffer Block will function properly against a momentary power failure of at least 300 ms. (See note 1.)

S8TS Series: S8TS-06024□

S8VS Series: S8VS-01524, S8VS-03024, S8VS-06024 (See note 2.), S8VS-06024A/B, S8VS-09024, S8VS-09024S, S8VS-09024A□/B□, S8VS-12024 (See note 2.), S8VS-12024A□/B□, S8VS-18024 (See note 2.), S8VS-18024A□/B□, S8VS-24024 (See note 2.), S8VS-24024A□/B□, and S8VS-48024A/B

S82K Series: S82K-03024, S82K-05024, S82K-□09024, and S82K-□10024

S8VM Series: S8VM-01524□□, S8VM-03024□□, S8VM-05024□□, S8VM-10024□□, S8VM-15024□□, S8VM-30024C, S8VM-60024C, and S8VM-15224C

S82J Series: S82J-02524□□, S82J-05024□□, S82J-10024□□ (See note 2.), S82J-15024□□, S82J-30024□, and S82J-60024□

Note: 1. The backup current must be less than 5 A (parallel operation connection is required if the backup current exceeds 2.5 A) and the Buffer Block must be fully charged. If three or more S8T-DCBU-02 Buffer Blocks are used in parallel operation and the backup current exceeds 5 A, the momentary power failure time that can be compensated for will be reduced.

- When connected to the S8VS-06024, S8VS-12024, S8VS-18024, S8VS-24024, or S82J-10024□□ Power Supply, the output voltage may increase by approximately 4 V for several 10 s of milliseconds after recovery from the momentary power failure. If any adverse effect is foreseen, connect a diode as shown below based on the guidelines given below.

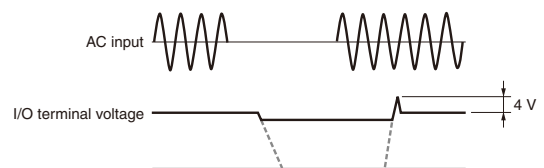

Guidelines for Selecting Diode

Type: Schottky barrier diode
 Withstanding voltage (V_{RRM}): At least twice the rated output voltage
 Forward current (I_F): At least twice the rated output current

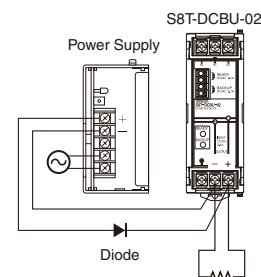

Power Supply To Be Connected

The power consumption of the S8T-DCBU-02 is approximately 10 W, so make sure that the output capacity of the connected Power Supply is sufficient.

If the S8T-DCBU-02 is connected to a previously installed power supply, the voltage may drop due to the power supply's overload protection, or backup operations may not be possible.

Note: Connect a Power Supply within the specified derating range, considering the power consumption of the S8T-DCBU-02.

Selecting the Power Supply

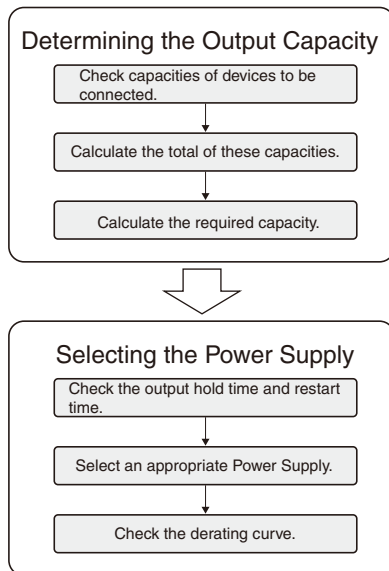

Determining the Output Capacity

1. Checking Capacities of Devices To Be Connected

Check the capacities (W) of the devices to be connected.

2. Calculating the Total Capacity (Including That of the S8T-DCBU-02 Buffer Block)

The S8T-DCBU-02 Buffer Block will consume the following power. Add this to the above capacities (W) of the devices to be connected to obtain the total capacity.

Vin = 24 V: 9.6 W max. (during charging)

Vin = 28 V: 11.2 W max. (during charging)

Calculation of the Total Capacity

$$\boxed{\text{Total capacity (W)}} = \boxed{\text{Capacities of devices (W)}} + \boxed{\text{Power consumption (W) of the S8T-DCBU-02}}$$

3. Calculating the Required Output Capacity

Determine the rate of allowance and apply this allowance rate to the total capacity calculated above to obtain the output capacity required by the Power Supply. Be sure to provide a sufficient allowance rate.

Calculation of the Total Power Supply Capacity

$$\boxed{\text{Required output capacity (W) of the Power Supply}} > \boxed{\text{Total capacity (W)}} \div \boxed{\text{Allowance rate}}$$

Example: Output voltage: 24 V

Capacities of devices: 36 W (output current: 1.5 A)

Allowance rate: 0.8

Required output capacity of the Power Supply > (36 W + 9.6 W) ÷ 0.8 = 57 W

Therefore, an S8TS-06024□ Power Supply, S8VS-06024□ Power Supply, or a Power Supply with a larger capacity is required.

Selecting the Power Supply To Be Connected

1. Checking the Output Hold Time and Restart Time of the Connected Power Supply

The relation between the momentary power failure time and the backup time required to compensate the failure is shown in the following illustration. As shown by the illustration, the backup time required from the S8T-DCBU-02 Buffer Block depends on the connected Power Supply even for the same momentary power failure time.

Calculation of the Required Backup Time

$$\boxed{\text{Required backup time}} > \boxed{\text{Momentary power failure time}} + \boxed{\text{Restart time of Power Supply}} - \boxed{\text{Output hold time of Power Supply}}$$

Relation between Momentary Power Failure and Backup Time

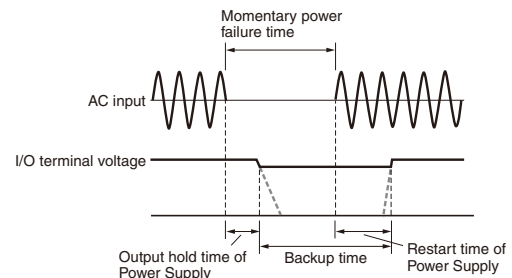

The output hold time and restart time of each Power Supply are shown in *Power Supply Output Hold Times (Reference Values)* on page 12 and *Power Supply Restart Times (Reference Values)* on page 13.

Example: S8T-DCBU-02: 1 Unit

Connected Power Supply: S8TS-06024□

Load current: 1 A

AC input voltage: 200 VAC

Assumed momentary power failure time: 300 ms

Required backup time > 300 ms + 270 ms - 100 ms = 470 ms

Refer to the graphs under *Backup Time* on page 10 to check whether the backup time is sufficient.

2. Selecting the Power Supply

After obtaining the output capacity required for the Power Supply and checking its output hold time and restart time as described above, select an appropriate Power Supply from the list under *Connectable Power Supplies* on page 3.

3. Checking the Derating Curve

Confirm that the total output capacity calculated in step 2, *Calculating the Total Capacity*, under *Determining the Output Capacity* is within the derating curve of the Power Supply. If the capacity exceeds the derating curve, increase the Power Supply capacity or use forced air cooling to reduce the ambient operating temperature.

Mounting

Mounting Direction

Standard mounting	Yes
Face-up mounting	No
Other mounting	No

Improper mounting will interfere with heat dissipation and may occasionally result in deterioration of or damage to internal parts. Use standard mounting only.

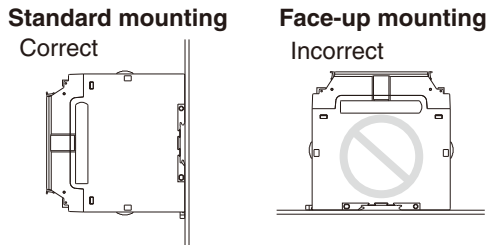

Connecting to the S8TS-06024

When connecting one or more S8T-DCBU-02 Blocks to the S8TS-06024 using Bus Line Connectors, connect them to either the left or right end of the Blocks. Heat dissipation will be interfered with if the S8T-DCBU-02 Blocks are not connected to the end.

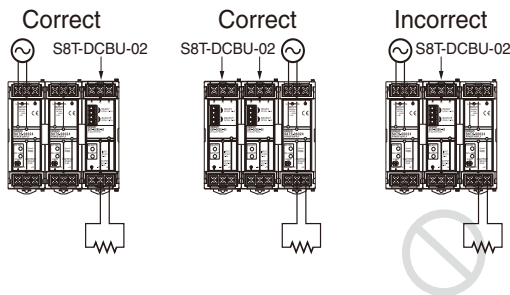

Wiring Connections

A load can be connected to either the Power Supply side or the S8T-DCBU-02 side.

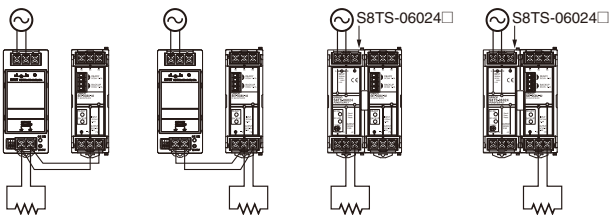

Note: Use the largest wire size possible and keep the wiring distance as short as possible. If the voltage drop caused by the wiring material is too large, the backup operation may not be sufficient.

Input Voltage

Input voltage range: 24 to 28 VDC

Confirm that an input voltage of at least 24 V is being supplied to the S8T-DCBU-02 input terminals.

Output Voltage

The output voltage for the backup operation is automatically adjusted internally by detecting the input voltage. The backup operation is started when the input voltage drops 2 V.

Note: The output voltage during the backup operation is a maximum of 2 V lower than the voltage input at an input voltage of 24 VDC.

Serial Connection

Two Blocks cannot be connected in series to increase the output voltage to 48 V or to create positive and negative outputs.

Parallel Connection

The output current and backup time for the backup operation can be increased by connecting Buffer Blocks in parallel.

Standard number of Buffer Blocks for parallel operation: 2
Maximum number of Buffer Blocks for parallel operation: 4

The backup time will be greatly reduced if three or more Blocks are connected in parallel and the output current for the backup operation exceeds 5 A. Refer to *Backup Time* on page 10 for details on the backup time during parallel operation.

Note: Although the number of Buffer Blocks that can be connected when using the S8TS-06024 is five when calculated from the current capacity of the Bus Line Connector, only a maximum of four S8T-DCBU-02 can actually be connected in parallel.

Using the Bus Line Connector

When connecting to the S8TS-06024, always use the S8T-BUS03 Bus Line Connector. This Connector connects only the DC lines. It does not connect AC lines.

S8T-BUS03 Bus Line Connector

The S8T-BUS03 Bus Line Connector is equipped with a selector to prevent incorrect connection to a power supply unit with a different output voltage specification. Slide the selector to the 24 V position.

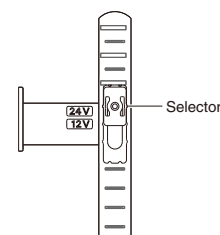

Inserting and Removing the Bus Line Connector

Pay attention to the following points to maintain electric characteristics.

- Do not insert and remove a Bus Line Connector more than 20 times.
- Do not touch the Bus Line Connector terminals.
- To remove a Bus Line Connector, insert a flat-blade screwdriver alternately at both ends.

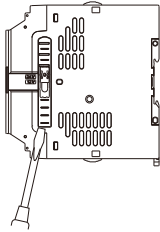

Mounting to DIN Rail

To mount the Buffer Block to DIN Rail, hook portion (A) of the Buffer Block onto the Rail and press the Buffer Block in direction (B).

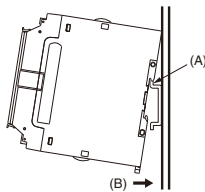

To dismount the Buffer Block, pull down portion (C) with a flat-blade screwdriver and pull out the Buffer Block.

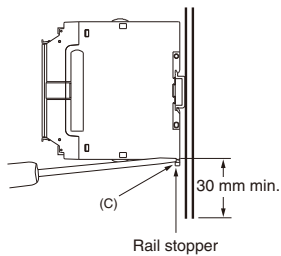

Checking Operation and Periodic Inspection

After connecting the Buffer Blocks, check the Buffer Block using the following procedure to confirm that it operates correctly for momentary power failures on the AC input. Use this procedure for periodic inspection as well.

1. Turn ON the AC power of the connected power supply.
2. Check the READY indicator on the S8T-DCBU-02 to confirm that it is lit.

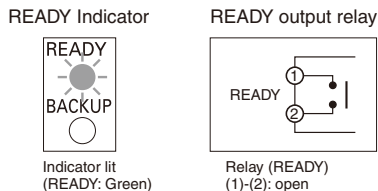

Note: Up to 60 seconds is required to charge the internal capacitor before the indicator lights.

3. Use a timer and create a momentary power failure on the AC input of the expected length of time. Considering variations in characteristics, using 140% or more of the power failure time is recommended.

Operation Check and Periodic Inspection

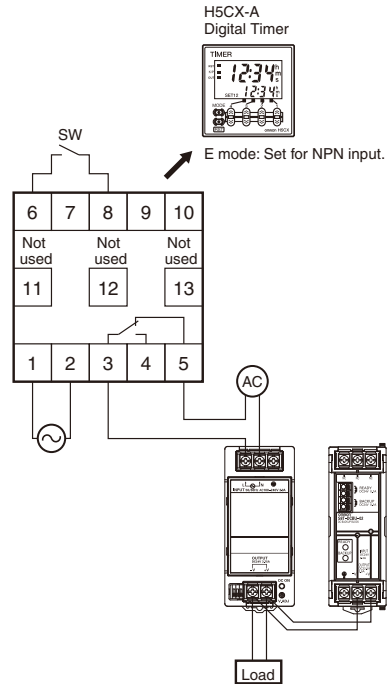

4. Check to confirm that the expected backup operation was performed. The operation of the BACKUP indicator and BACKUP output should be as shown below during the backup operation. Check these as well.

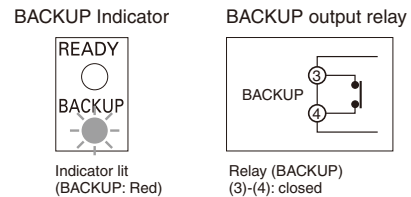

Note: Check the backup operation under conditions that are safe and will cause no problems if the backup operation fails.

■ Functions

READY Operation

The READY indicator and READY output will function as shown below after the internal capacitor is completely charged and the Buffer Block is ready to perform the backup operation. Up to 60 seconds is required for the capacitor to charge completely.

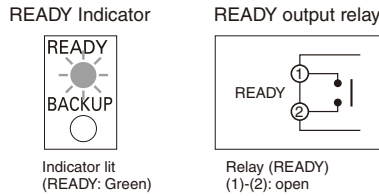

The following status will occur if there is an error in the charge voltage of the internal capacitor or the output voltage of the S8T-DCBU-02.

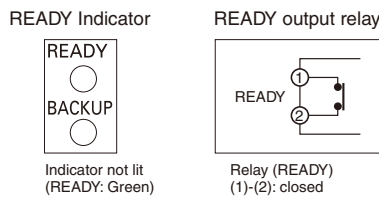

The backup operation will not be sufficient or will fail under the above status. If this status occurs, immediately remove the cause of the error, such as the following causes.

1. The connected DC voltage is 23 V or less.
2. The terminals have been connected in reverse, a wire is broken, or wiring is otherwise not correct.
3. The overvoltage protection circuit has operated.
4. The overcurrent protection circuit of the connected power supply has operated.

Note: The contact capacity of the output relay is 0.1 A at 24 VDC.

Backup Operation

The S8T-DCBU-02 will switch to the backup operation if a voltage drop is detected on the connected power supply.

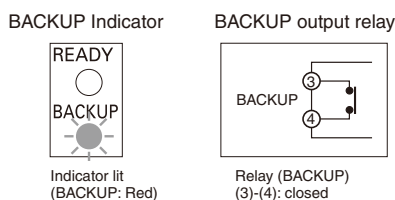

When the backup operation functions, the energy in the internal capacitor will be discharged to the load. When the voltage of the power supply then recovers, the S8T-DCBU-02 will start charging the capacitor. Up to 60 seconds is required to charge the capacitor completely. The backup operation may therefore not function for the required period if the backup operation starts while the capacitor is being charged.

The following are examples in which the backup operation may not be sufficient.

1. The backup operation starts within 60 seconds after turning ON the power.
2. The backup operation is started consecutively within 60 seconds of the previous backup operation.
3. A rapid change in the load or other factor causes the DC voltage to drop, resulting in the backup operation, and then the backup operation occurs again within 60 seconds.

The READY indicator and READY output will function as shown below when the internal capacitor is being charged.

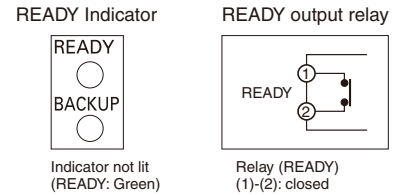

- Note:**
1. The contact capacity of the output relay is 0.1 A at 24 VDC.
 2. The backup operation may be repeatedly performed if the connected power supply is overloaded. Remove the cause of the overload immediately.
 3. The backup operation does not detect drops in the AC input.

Overload Protection

The S8T-DCBU-02 is provided with an overload protection function that protects the Power Supply from possible damage due to short-circuits and overcurrents by automatically decreasing the output if the overcurrent reaches 5.8 to 6.8 A. When the output current falls within the rated range, the overload protection function is automatically cleared.

Note: Internal parts may occasionally deteriorate or be damaged if a short-circuited or other overcurrent state continues during operation.

Overvoltage Protection

If a voltage that is higher than the specified input voltage range is input or the output voltage exceeds the specified voltage, the overvoltage protection circuit will operate at between 31 and 36 V to shut OFF the output voltage and protect the load from damage due to overvoltages. To reset the Buffer Block, turn OFF the input power for at least 1 minute and then turn it back ON.

- Note:**
1. Remove the cause of the overvoltage before turn the input power back ON.
 2. The backup operation will not be performed when the overvoltage protection is performed to shut OFF the output.

Reverse Connection Protection

The S8T-DCBU-02 will be protected even if the positive and negative I/O terminals are connected in reverse.

Nomenclature

Buffer Block

S8T-DCBU-02

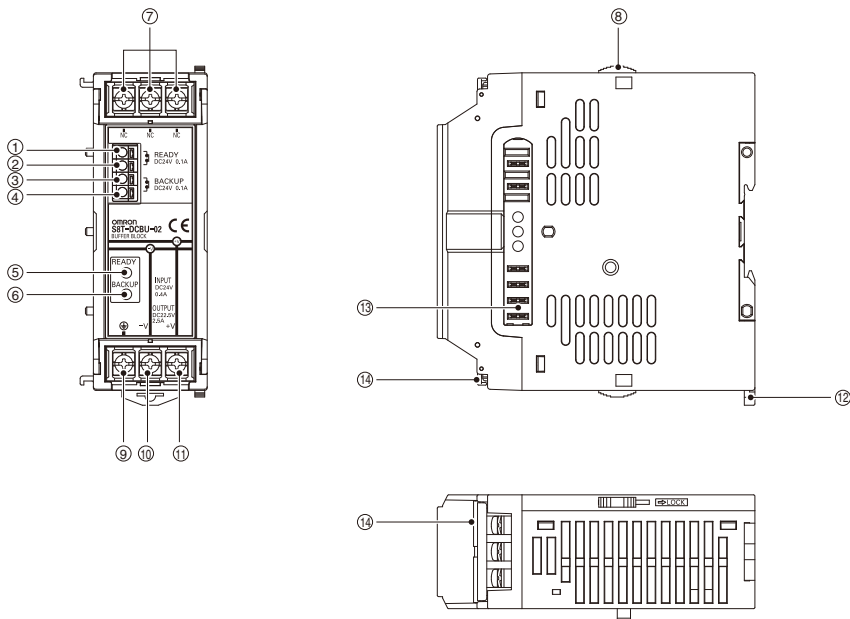

- ①, ②: READY Output: NC contact
- ③, ④: BACKUP Output: NC contact
- ⑤: READY Indicator (READY: Green)
- ⑥: BACKUP Indicator (BACKUP: Red)
- ⑦: NC
- ⑧: Slider

- ⑨: Protective Earthing Terminal (⊕)
- ⑩: I/O Terminal (-V)
- ⑪: I/O Terminal (+V)
- ⑫: Rail Stopper
- ⑬: Connecting part of Bus Line Connector
- ⑭: Terminal Cover

Bus Line Connector

S8T-BUS03

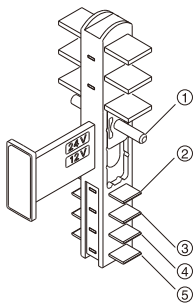

- ①: Selector
- ②: ⊕ Bus Line Connector terminal
- ③: NC
- ④: DC Bus Line Connector Terminal (+V)
- ⑤: DC Bus Line Terminal (-V)

Engineering Data

Derating Curve

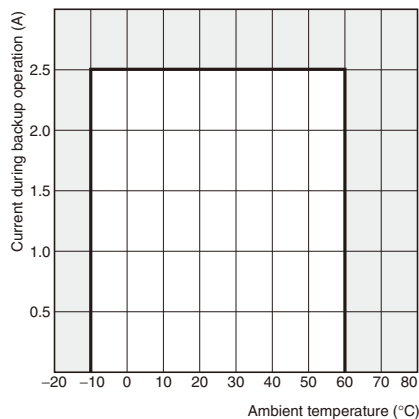

- Note:**
1. If natural air circulation is limited, use the forced air cooling to prevent overheating.
 2. The ambient temperature is measured at a point 50 mm below the Buffer Block.
 3. Check the derating curve for each power supply to be connected. Refer to *Connections to the S8TS (Reference Values)* on page 11 for details on the derating curves when connecting the Buffer Block to the S8TS-06024□.

Time Charts

Startup

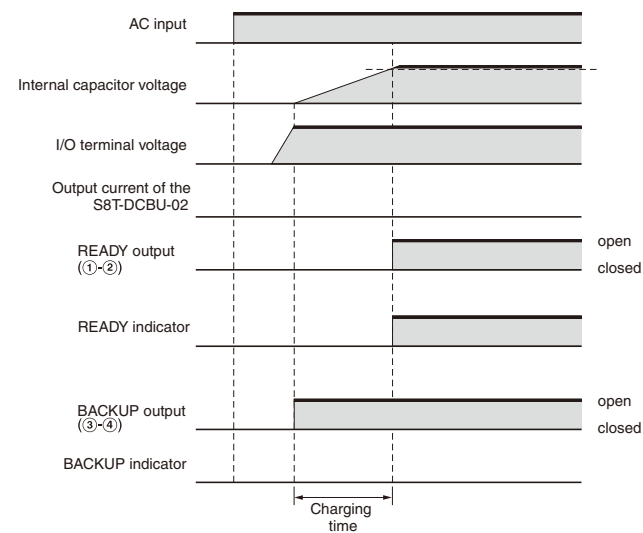

Momentary Power Failure or Instantaneous Voltage Drop

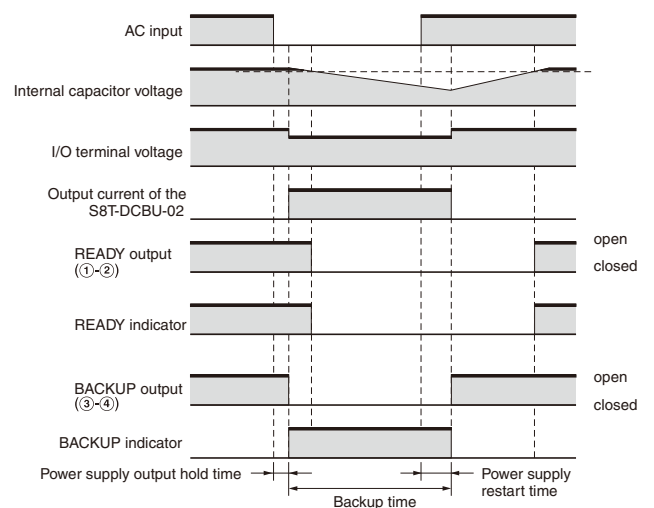

Power Supply Interrupted or Stopped

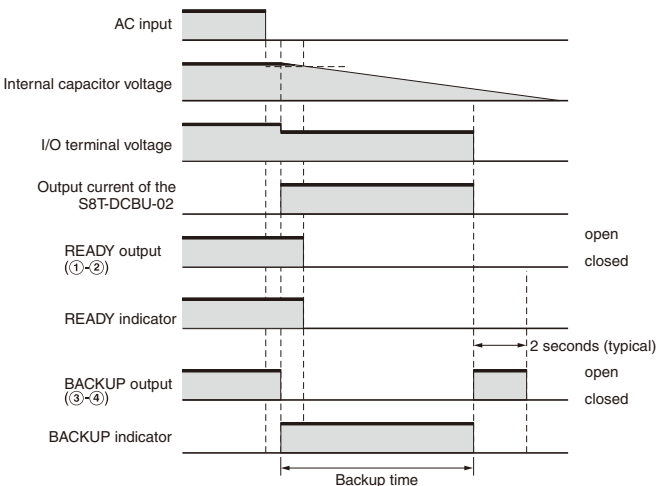

■ Backup Time

Single Operation

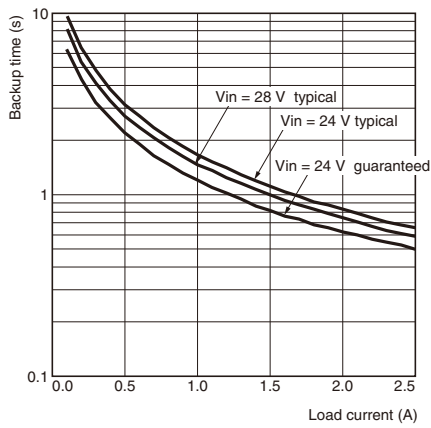

Parallel Operation with 2 Blocks

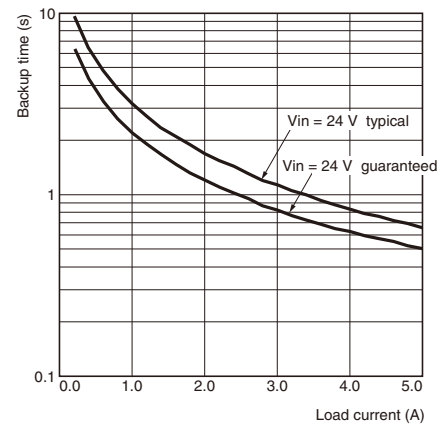

Parallel Operation with 3 Blocks

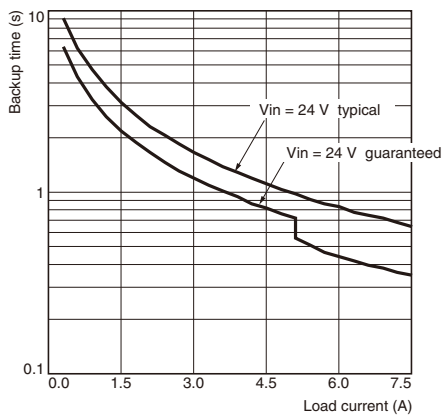

Parallel Operation with 4 Blocks

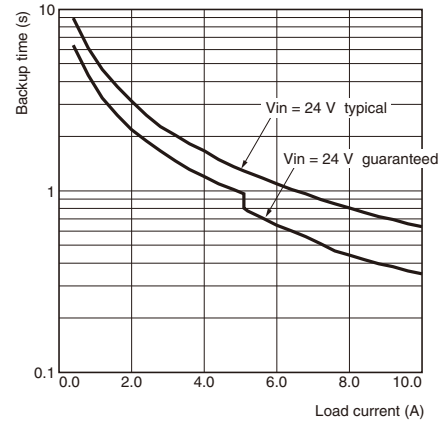

- Note:**
1. The backup time may be reduced if a fixed power load (such as a DC-DC converter) is connected.
 2. If the input voltage increases, the output voltage for the backup operation will also increase, reducing the backup time due to the higher power consumption of the load.

■ Connections to the S8TS (Reference Values)

Derating Curves of the S8TS-06024□ When Connecting to the S8T-DCBU-02

Number of S8TS-06024□ Blocks	S8TS-06024□ rated input	Number of S8T-DCBU-02 Blocks	Derating curve	Rated output power	
1	200 to 240 VAC	1	*1	50 W	
	100 to 120 VAC	1	*2	50 W	
1 (+1)	100 to 120/200 to 240 VAC	1	*3	44 W	
2		1	*4	110 W	
2 (+1)		1	*5	98 W	
3		1	*6	170 W	
3 (+1)		1	*7	152 W	
4		1	*8	230 W	
4 (+1)		1	*9	206 W	
1		200 to 240 VAC	2	*10	40 W
		100 to 120 VAC	2	*11	40 W
1 (+1)		100 to 120/200 to 240 VAC	2	*12	34 W
2	2		*13	100 W	
2 (+1)	2		*14	88 W	
3	2		*15	160 W	
3 (+1)	2		*16	142 W	
1	200 to 240 VAC		3	*17	30 W
	100 to 120 VAC		3	*18	30 W
1 (+1)	100 to 120/200 to 240 VAC		3	*19	24 W
2		3	*20	90 W	
2 (+1)		3	*21	78 W	
1		200 to 240 VAC	4	*22	20 W
	100 to 120 VAC	4	*23	20 W	

- Note:**
1. "+1" indicates the addition of one more S8TS-06024□ Basic Block if a redundant system is used.
 2. If there is a derating problem, use forced air cooling.
 3. The ambient temperature is specified at a place 50 mm below the Product.
 4. The energy consumption of the S8T-DCBU-02 (approximately 10 W per Block) from the S8TS-06024□ reduces the total output capacity when more than one S8TS-06024□ Block is connected.
 5. The rated output current of the S8T-DCBU-02 is 2.5 A per Block regardless of the number of S8TS-06024□ Basic Blocks that are connected.

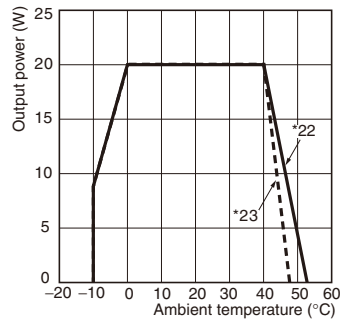
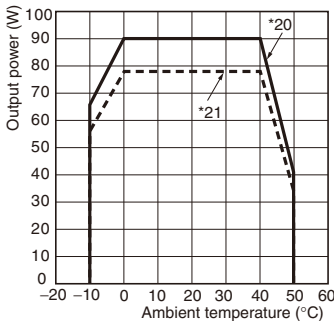
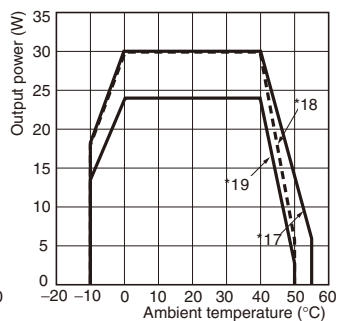
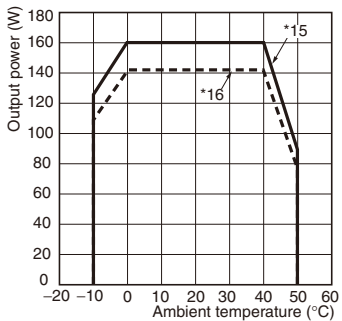
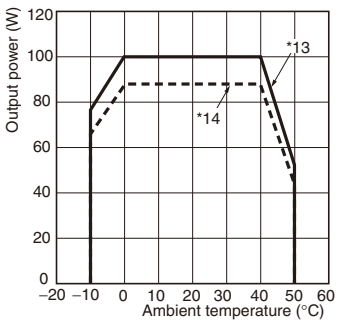
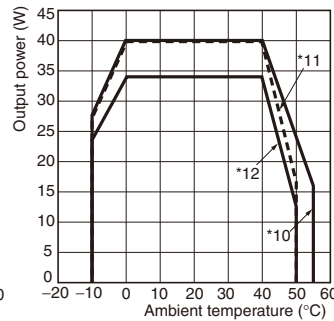
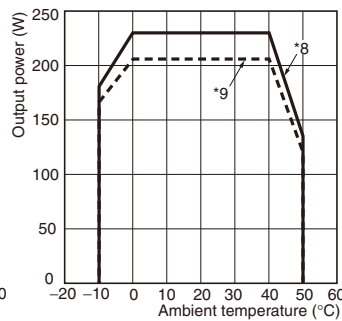
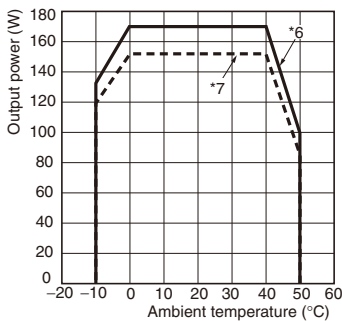
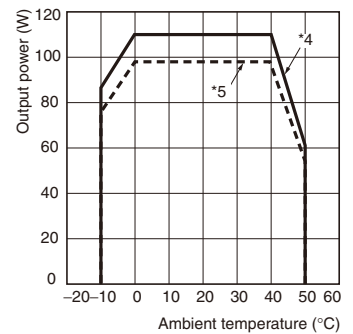
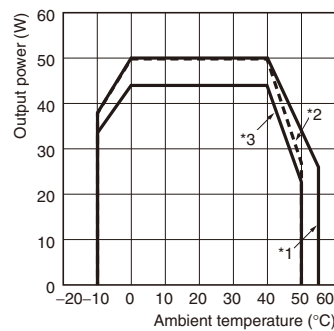

■ Power Supply Output Hold Times (Reference Values)

The rated currents are given for load currents.

Series	Model number	Load current (A)	Output hold time (ms)		
			100 VAC	200 VAC	
S8TS	06024□	0.5	163	167	
		1	98	100	
		1.5	70	70	
		2.1	56	58	
S8VS	01524	0.1	114	472	
		0.2	78.4	344	
		0.25	68.8	300	
	03024	0.25	124	526	
		0.5	72	334	
		0.75	47.4	242	
	06024□	0.9	36.8	204	
		0.5	158	664	
		1	88	382	
	09024□□	1.5	57	266	
		2.1	36	194	
		1	118	508	
	12024□□	2	58	274	
		2.95	34	176	
		1	262	262	
	18024□□	2	148	148	
		3	102	102	
		4	75	75	
		4.2	72	72	
		2	225	230	
	24024□□	4	107	120	
		6	71	75	
		6.3	65	70	
		2.5	170	170	
	48024□	5	68	72	
		7.5	52	56	
		8.4	40	44	
		2.5	291	268	
	S82K	03024	5.0	147	157
			7.5	97	103
			10.0	75	77
			0.25	192	792
05024		0.5	120	515	
		0.75	82	375	
		0.9	66	315	
09024/10024		0.5	118	505	
		1	66	295	
		1.5	41	200	
	1.7	35	178		
P09024/ P10024	1	130	130		
	2	67	73		
	3	41	46		
	3.4	34	39		
S82J	02524□□	1	140	124	
		2	75	68	
		3	46	41	
		3.4	41	36	
	05024□□	0.2	170	700	
		0.4	105	470	
		0.6	74	345	
		0.7	62	300	
	10024□□	0.5	117	524	
		1	65	300	
1.5		44	210		
1.7		38	185		
1		133	600		
30024C	2	71	325		
	3	46	210		
	3.7	37	173		

Series	Model number	Load current (A)	Output hold time (ms)		
			100 VAC	200 VAC	
S82J	15024□□	1.5	133	144	
		3	66	73	
		4.5	42	50	
		5.3	34	40	
	30024□	2.5	190	200	
		5	100	105	
		7.5	68	70	
		10	48	50	
	60024□	2.5	353	365	
		5	193	203	
		7.5	130	138	
		10	98	104	
	S8VM	01524□□	0.1	94	414
			0.2	66	308
0.25			52	258	
03024□□		0.1	154	492	
		0.2	114	516	
		0.3	84	414	
		0.4	72	340	
		0.5	56	290	
		0.6	46	248	
		0.7	36	218	
		0.8	28	202	
		0.9	22	166	
		05024□□	0.1	218	218
0.2			164	170	
0.4			114	110	
0.6			84	84	
0.8			68	72	
1.0			58	54	
1.2			44	44	
1.4			36	38	
1.6			34	32	
1.8			28	30	
10024□□		0.5	240	232	
		1.0	136	132	
		1.5	94	92	
		2.0	70	70	
		2.5	52	56	
		3.0	40	44	
		3.5	38	38	
		3.7	32	30	
		15024□□	0.5	332	334
			1.0	192	196
1.5	136		140		
2.0	102		108		
2.5	80		86		
3.0	66		66		
3.5	60		58		
4.0	52		50		
4.5	44		44		
5.0	54		54		
30024C	5.3	34	38		
	2.5	162	169		
	5.0	84	84		
	7.5	52	57		
60024C	10.0	43	41		
	2.5	304	306		
	5.0	170	158		
15224C	7.5	116	121		
	10.0	88	88		
	2.5	680	520		
	5.0	644	517		
		7.5	638	515	
		10.0	635	510	

■ Power Supply Restart Times (Reference Values)

Series	Model number	Restart time (ms)					
		Momentary power failure time: 300 ms		Momentary power failure time: 500 ms		Momentary power failure time: 1,000 ms	
		100 VAC	200 VAC	100 VAC	200 VAC	100 VAC	200 VAC
S8TS	06024□	320	270	320	270	345	290
S8VS	01524	5.4	5.6	6	4.8	6.2	5
	03024	390	110	456	140	576	196
	06024	330	8	424	200	496	300
	06024A/06024B	220	5	280	95	380	155
	09024/09024S	312	6	378	186	512	308
	09024A□/09024B□	220	5	286	100	390	157
	12024□□	360	248	400	288	432	322
	18024	288	252	306	276	388	356
	18024A□/18024B□	230	198	247	216	263	235
	24024	266	236	272	248	328	300
	24024A□/24024B□	5	5	5	5	15	5
	48024□	53	3	267	229	278	242
S82K	03024	14	6	14	6	14	6
	05024	16	8	16	8	16	8
	09024/10024	5	5	60	52	65	60
	P09024/P10024	68	54	68	54	70	56
S82J	02524□□	11	10	11	10	12	11
	05024□□	188	72	200	82	224	100
	10024□□	175	4	198	82	218	98
	15024□□	210	76	216	76	218	76
	30024□	117	70	117	70	117	70
	60024□	158	86	158	86	158	86
S8VM	01524□□	356	152	376	164	420	180
	03024□□	350	150	372	160	420	184
	05024□□	240	196	248	196	270	216
	10024□□	248	208	256	208	280	220
	15024□□	250	226	272	216	300	236
	30024C	62	48	64	50	74	60
	60024C	366	198	380	200	436	276
	15224C	556	472	568	480	576	488

Dimensions

Note: All units are in millimeters unless otherwise indicated.

■ Buffer Block and Bus Line Connector

Buffer Block

S8T-DCBU-02

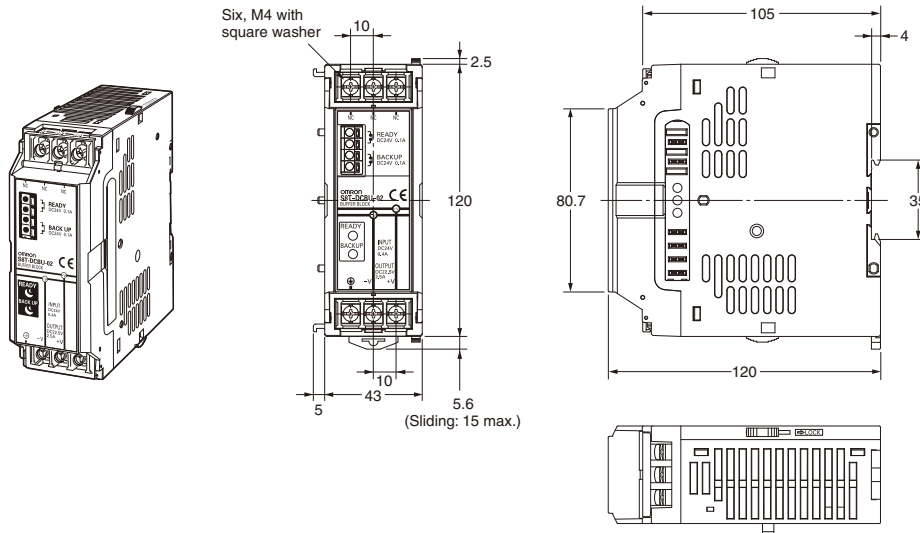

Bus Line Connector

S8T-BUS03

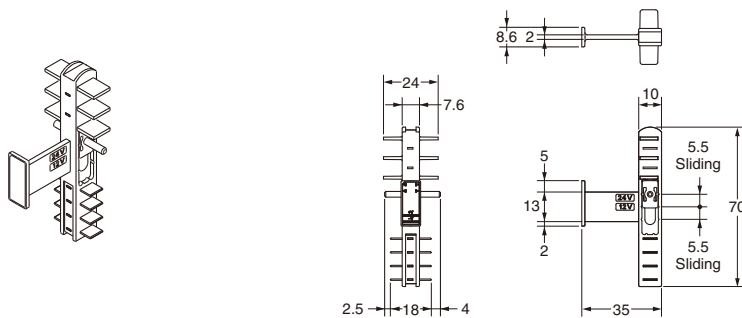

■ DIN Rails (Order Separately)

Mounting Rails (Material: Aluminum)

PFP-100N

PFP-50N

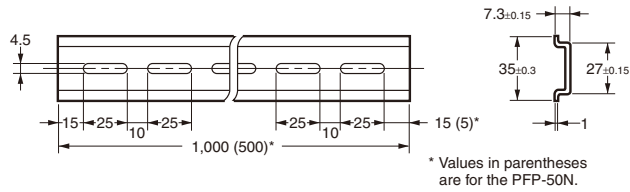
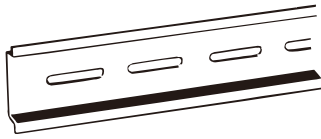

PFP-100N2

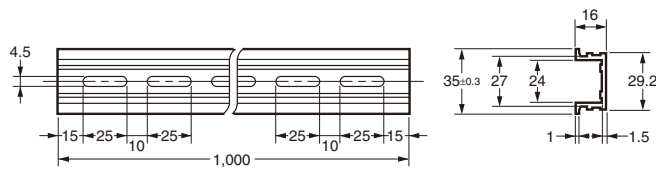
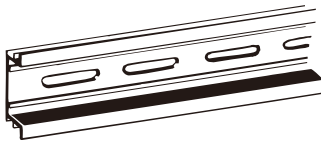

End Plate

PFP-M

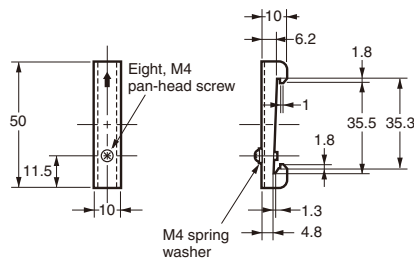

Safety Precautions

CAUTION

Installation and Environment

Minor fires may occasionally occur or wires may become detached causing the backup operation to fail if screws are not tightened properly. Tighten terminal screws to a torque of 1.08 N·m so that they do not become loose.



Minor electric shock may occasionally occur. Do not remove the connector cover unless connecting the Bus Line Connector.



Minor electric shock may occasionally occur and the backup operation will fail if the connector becomes disconnected. Be sure to lock the slider and rail stopper securely when connecting the Basic Block and the S8T-DCBU-02 to prevent the connector from being disconnected due to vibration.



Internal parts may occasionally deteriorate or be damaged and the backup operation may not be sufficient. Do not use the S8T-DCBU-02 for applications that subject the load to frequent inrush currents or overload currents.



The S8T-DCBU-02 may occasionally be damaged. Do not allow any clippings or cuttings to enter the S8T-DCBU-02 during mounting.



Operation

Minor burns may occasionally occur. Do not touch the S8T-DCBU-02 while power is being supplied or immediately after power is turned OFF.



Minor electric shock may occasionally occur. Do not add or remove the S8T-DCBU-02 while power is being supplied.



Maintenance

Minor electric shock may occasionally occur. Do not disassemble the S8T-DCBU-02 or touch the interior of the S8T-DCBU-02.



Precautions for Safe Use

Observe the following precautions to ensure safety when using the S8T-DCBU-02.

Setting and Selecting Power Supply to be Connected

Do not connect a power supply other than the ones specified below.

Specified Power Supply (SELV Power Supply): S8TS Series, S8VS Series, S8VM Series, S82K Series, S82J Series, S8PS Series (except S8PS-60024).

Only power supplies with an output voltage of 24 V and an output capacity of 9.6 W or more can be connected.

When selecting the power supply to be connected, take both the operation current and power of S8T-DCBU-02 into consideration, allowing sufficient margin.

Mounting

Improper mounting will interfere with heat dissipation and may occasionally result in deterioration or damage of internal parts. Use the specified mounting method only.

Ensure sufficient heat dissipation when installing the Product to increase its long-term reliability.

Natural cooling is used, so mount the S8T-DCBU-02 so that there is airflow around it.

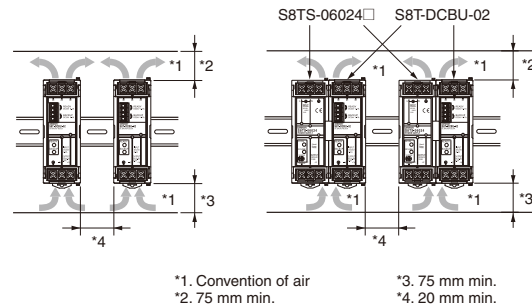

Installation/Wiring

Minor electric shock or malfunction may possibly occur. Connect the ground wire completely.

Minor fires may possibly occur. Check the terminals to be sure they are wired correctly.

Do not apply more than 100-N force to the terminal block when tightening the terminals.

Close the terminal cover to help prevent short-circuiting terminals with foreign objects.

Be sure to remove the sheets covering the S8T-DCBU-02 for machining before turning ON the power so that they do not interfere with heat dissipation.

Use the wiring material specified in the following table to protect wires from smoking or ignition due to abnormal loads. Also, the backup operation may not be sufficient due to voltage drop in the wiring material if thin wiring materials are used.

I/O Terminals

Load current	Number of connected S8T-DCBU-02	Recommended wire diameter
Up to 2.5 A	1	AWG 14 to 20 (cross-sectional area: 0.517 to 2.081 mm ²)
Up to 5.0 A	2	AWG 14 to 18 (cross-sectional area: 0.823 to 2.081 mm ²)
Up to 7.5 A	3	AWG 14 to 16 (cross-sectional area: 1.309 to 2.081 mm ²)
Up to 10 A	4	AWG 14 (cross-sectional area: 2.081 mm ²)

Signal output terminals: AWG 14 to 22 (Cross-sectional area: 0.326 to 1.309 mm²)
(Wire stripping length: 11 mm)

Installation Environment

Do not use the S8T-DCBU-02 in locations subject to shocks or vibrations. In particular, install the S8T-DCBU-02 as far away as possible from contactors or other devices that are a vibration source. Install a PFP-M End Plate on each end of the product.

Install the S8T-DCBU-02 well away from any sources of strong, high-frequency noise and surge.

Ambient Operating Environment and Storage Environment

Store the S8T-DCBU-02 at an ambient temperature of -25 to $+65^{\circ}\text{C}$, and a relative humidity of 25% to 90%.

The internal parts may occasionally deteriorate or be damaged. Do not use the S8T-DCBU-02 outside the derating range (i.e., under conditions indicated by the shaded area () in the derating curve diagram on page 9.)

Use the S8T-DCBU-02 at a relative humidity of 25% to 85%.

Do not use the S8T-DCBU-02 in locations subjected to direct sunlight.

Do not use the S8T-DCBU-02 in locations where liquid, foreign matter, or corrosive gases may enter the interior of the S8T-DCBU-02.

Precautions in Using

After connecting the devices to the S8T-DCBU-02, check whether sufficient backup is performed correctly by operating the S8T-DCBU-02.

Check the load current using the actual system in advance to confirm that there is sufficient leeway in the backup time.

Check to confirm that the READY indicator and the output function correctly. The backup operation may not be sufficient if the READY indicator and output do not function correctly.

The S8T-DCBU-02 will perform the backup operation not only for momentary power failures or voltage drops, but also when the input power is OFF. The backup time is particularly long for light loads. Check the devices connected to the S8T-DCBU-02 to be sure it has stopped operation correctly.

Periodic Inspection and Periodic Replacement

The S8T-DCBU-02 contains built-in electrolytic capacitors, which have a limited life. Perform periodic inspection and replacement. The performance of the electrolytic capacitor will deteriorate as the total operating time increases, eventually leading to insufficient performance. Refer to the following guidelines for periodic replacement.

Ambient temperature	Guideline of replacement	
	With space between the Units	Connected to S8TS
30°C max.	15 years	15 years
40°C	12 years	8.5 years
50°C	6 years	5.5 years (See note.)
60°C	3 years	---

Note: The load ratio of the S8TS is limited to 60% due to the derating curve.

Handling the Bus Line Connector

Do not drop the Bus Line Connector or subject it to strong shock.

Do not connect and disconnect the Bus Line Connector more than 20 times. Also, do not touch the terminals on the Bus Line Connector. Connection failure may cause deterioration of electric performance.

Troubleshooting

The following table lists the errors that may occur when the S8T-DCBU-02 is used, along with their probable causes and remedies. Check the relevant items.

When	Cause	Description	Remedies
During installation	The S8TS-06024□ and S8T-DCBU-02 cannot be connected.	The Bus Line Connector is provided with a selector to prevent misconnection of 12-V and 5-V S8TS Blocks. Connection will not be possible if the selector is set for the wrong type of Block.	Set the selector on the S8T-BUS03 Bus Line Connector to 24 V. Refer to <i>S8T-BUS03 Bus Line Connector</i> on page 5.
When checking operation (Refer to <i>Checking Operation and Periodic Inspection</i> on page 6.)	The S8TS-06024□ when connected does not operate in step 2 of the operation checking procedure.	The AC line is not connected by the S8T-BUS03 Bus Line Connector when the S8T-DCBU-02 is connected. The S8T-DCBU-02 may be connected between two S8TS-06024□ Blocks.	Connect the S8T-DCBU-02 to the right or left end of the connected Blocks. Refer to <i>Mounting</i> on page 5.
	The READY indicator on the S8T-DCBU-02 does not light in step 2 of the operation checking procedure when connected to the S8TS.	Power is supplied via the S8T-BUS03 Bus Line Connector when the S8T-DCBU-02 and S8TS are connected. The Bus Line Connector may not be connected.	Connect the S8T-DCBU-02 and S8TS-06024□ using an S8T-BUS03 Bus Line Connector. Refer to <i>Basic Configuration</i> on page 1.
		A Bus Line Connector that does not connect the DC line (such as the S8T-BUS02) may be connected.	Connect the S8T-DCBU-02 and S8TS-06024□ using an S8T-BUS03 Bus Line Connector. Refer to <i>Basic Configuration</i> on page 1.
	The READY indicator on the S8T-DCBU-02 does not light in step 2 of the operation checking procedure.	Up to 60 seconds is required to completely charge the internal capacitor after the input power has been turned ON. The READY indicator will not turn ON immediately after the input power is turned ON.	Check that the READY indicator lights after 60 seconds has passed since turning ON the input power. Refer to <i>READY Operation</i> on page 7.
		The positive and negative I/O terminals on the S8T-DCBU-02 may be connected in reverse or the power supply may be connected to an incorrect terminal (e.g., an NC terminal).	Check the wiring to be sure it is correct. The internal circuits of the S8T-DCBU-02 will be protected even if the positive and negative terminals are reversed. Correct the polarity and turn ON the power supply again. Refer to <i>Reverse Connection Protection</i> on page 7.
		The voltage input to the S8T-DCBU-02 may be 23 V or less.	Check the I/O terminals on the S8T-DCBU-02 and adjust the voltage output using the output voltage adjuster (V. ADJ) of the connected power supply so that it is 24 V or higher. Refer to <i>Input Voltage</i> on page 5.
	The backup operation is not performed for the expected backup time in step 4 of the operation checking procedure.	Overcurrent protection on the connected power supply may have operated and the voltage may have dropped to below 23 V.	The S8T-DCBU-02 consumes 0.4 A, so the rated current of the connected power supply cannot be delivered completely to the load. Increase the capacity of the connected power supply. Refer to <i>Selecting the Power Supply</i> on page 4.
		The restart time of the connected power supply after recovery from momentary power failures may be too long.	The momentary power failure time differs from the backup time required to compensate for it. Change to a power supply with a shorter restart time or connect S8T-DCBU-02 Blocks in parallel to increase the backup time. Refer to <i>Selecting the Power Supply</i> on page 4.
		The voltage during the backup operation may be high, increasing the power consumption during the backup operation.	The output voltage during the backup operation is automatically adjusted based on detecting the voltage input to the S8T-DCBU-02. Connect S8T-DCBU-02 Blocks in parallel to increase the backup time. Refer to <i>Parallel Connection</i> on page 5.
		The output current during the backup operation may be higher than expected.	Connect S8T-DCBU-02 Blocks in parallel to increase the backup time. Refer to <i>Parallel Connection</i> on page 5.
The voltage output for the backup operation is low in step 4 of the operation checking procedure.	Overcurrent protection on the connected power supply may have operated and the voltage input to the S8T-DCBU-02 may have dropped to below 24 V.	The S8T-DCBU-02 consumes 0.4 A, so the rated current of the connected power supply cannot be delivered completely to the load. Increase the capacity of the connected power supply. Refer to <i>Selecting the Power Supply</i> on page 4.	
	The wiring to the load is too long or too thin, causing excessive voltage drop.	Use the thickest wire and shortest distance possible. The output voltage during backup will be up to 2 V lower than the input voltage. Refer to <i>Wiring Connections</i> on page 5.	
When checking operation (Refer to <i>Checking Operation and Periodic Inspection</i> on page 6.)	The voltage output for the backup operation is low in step 4 of the operation checking procedure.	Overcurrent protection may have operated on the S8T-DCBU-02.	Allow for leeway for the load capacity in the application or increase the output current during the backup operation by connecting S8T-DCBU-02 Blocks in parallel. Refer to <i>Parallel Connection</i> on page 5.

When	Cause	Description	Remedies
When checking operation (Refer to <i>Checking Operation and Periodic Inspection</i> on page 6.)	The BACKUP indicator does not light in step 4 of the operation checking procedure.	The output hold time of the connected power supply may be sufficient to handle the momentary power failure.	Use a timer to increase the power failure of the AC input from the connected power supply and confirm that the BACKUP indicator lights. Refer to <i>Selecting the Power Supply</i> on page 4.
		The voltage output from the S8T-DCBU-02 during the backup operation may be lower because overcurrent protection has operated in the S8T-DCBU-02.	Allow for leeway for the load capacity in the application or increase the output current during the backup operation by connecting S8T-DCBU-02 Blocks in parallel. Refer to <i>Parallel Connection</i> on page 5.
During actual operation	The READY indicator is not lit and the READY output is OFF.	The input voltage to the S8T-DCBU-02 may be 23 V or less.	Check the voltage at the I/O terminals of the S8T-DCBU-02 and adjust the voltage output using the output voltage adjuster (V. ADJ) of the connected power supply so that it is 24 V or higher. Refer to <i>Input Voltage</i> on page 5.
		A voltage of approximately 31 V or higher may be input to the I/O terminals of the S8T-DCBU-02, causing the overvoltage protection circuit to operate.	Clear the overvoltage protection (turn OFF the input power for 1 minute or longer and then turn it back ON). Refer to <i>Overvoltage Protection</i> on page 7.
	The backup time has become shorter.	It's possible that momentary power failures are occurring consecutively.	The backup time is measured when the built-in electrolytic capacitors are fully charged. If momentary power failures occur within one minute of each other, the charge will not be complete and the backup time will be shorter. Refer to <i>Backup Operation</i> on page 7.
		It's possible that the characteristics of the built-in electrolytic capacitors have deteriorated.	Electrolytic capacitors are built into the Block and these capacitors have a limited life. When an electrolytic capacitor exceeds its useful life, its capacity will decrease and other characteristics will deteriorate. This will cause the backup time to be shorter. Refer to <i>Operation Check and Periodic Inspection</i> on page 6 and to <i>Periodic Inspection and Periodic Replacement</i> on page 17.
	There is chattering on the READY output.	The input voltage of the S8T-DCBU-02 may be very close to 23 V.	Check the voltage at the I/O terminals of the S8T-DCBU-02 and adjust the voltage output using the output voltage adjuster (V. ADJ) of the connected power supply so that it is 24 V or higher. Refer to <i>Input Voltage</i> on page 5.
	The output voltage is not restored even after the power supply is restored following a momentary power failure.	Protection on the connected power supply may have operated, stopping the operation of the power supply.	Clear the protection function of the connected power supply.
The backup operation is performed repeatedly.	If more than one S8TS-06024□ Block is connected, one of the Blocks may be faulty.	Replace the faulty S8TS-06024□ Block.	
	An overcurrent status caused by load fluctuation may exist in the connected power supply.	Allow for leeway for the load capacity in the application or increase the capacity of the connected power supply. Refer to <i>Backup Operation</i> on page 7.	

ALL DIMENSIONS SHOWN ARE IN MILLIMETERS.

To convert millimeters into inches, multiply by 0.03937. To convert grams into ounces, multiply by 0.03527.

In the interest of product improvement, specifications are subject to change without notice.

Read and Understand This Catalog

Please read and understand this catalog before purchasing the products. Please consult your OMRON representative if you have any questions or comments.

Warranty and Limitations of Liability

WARRANTY

OMRON's exclusive warranty is that the products are free from defects in materials and workmanship for a period of one year (or other period if specified) from date of sale by OMRON.

OMRON MAKES NO WARRANTY OR REPRESENTATION, EXPRESS OR IMPLIED, REGARDING NON-INFRINGEMENT, MERCHANTABILITY, OR FITNESS FOR PARTICULAR PURPOSE OF THE PRODUCTS. ANY BUYER OR USER ACKNOWLEDGES THAT THE BUYER OR USER ALONE HAS DETERMINED THAT THE PRODUCTS WILL SUITABLY MEET THE REQUIREMENTS OF THEIR INTENDED USE. OMRON DISCLAIMS ALL OTHER WARRANTIES, EXPRESS OR IMPLIED.

LIMITATIONS OF LIABILITY

OMRON SHALL NOT BE RESPONSIBLE FOR SPECIAL, INDIRECT, OR CONSEQUENTIAL DAMAGES, LOSS OF PROFITS, OR COMMERCIAL LOSS IN ANY WAY CONNECTED WITH THE PRODUCTS, WHETHER SUCH CLAIM IS BASED ON CONTRACT, WARRANTY, NEGLIGENCE, OR STRICT LIABILITY.

In no event shall responsibility of OMRON for any act exceed the individual price of the product on which liability is asserted.

IN NO EVENT SHALL OMRON BE RESPONSIBLE FOR WARRANTY, REPAIR, OR OTHER CLAIMS REGARDING THE PRODUCTS UNLESS OMRON'S ANALYSIS CONFIRMS THAT THE PRODUCTS WERE PROPERLY HANDLED, STORED, INSTALLED, AND MAINTAINED AND NOT SUBJECT TO CONTAMINATION, ABUSE, MISUSE, OR INAPPROPRIATE MODIFICATION OR REPAIR.

Application Considerations

SUITABILITY FOR USE

OMRON shall not be responsible for conformity with any standards, codes, or regulations that apply to the combination of products in the customer's application or use of the product.

At the customer's request, OMRON will provide applicable third party certification documents identifying ratings and limitations of use that apply to the products. This information by itself is not sufficient for a complete determination of the suitability of the products in combination with the end product, machine, system, or other application or use.

The following are some examples of applications for which particular attention must be given. This is not intended to be an exhaustive list of all possible uses of the products, nor is it intended to imply that the uses listed may be suitable for the products:

- Outdoor use, uses involving potential chemical contamination or electrical interference, or conditions or uses not described in this catalog.
- Nuclear energy control systems, combustion systems, railroad systems, aviation systems, medical equipment, amusement machines, vehicles, safety equipment, and installations subject to separate industry or government regulations.
- Systems, machines, and equipment that could present a risk to life or property.

Please know and observe all prohibitions of use applicable to the products.

NEVER USE THE PRODUCTS FOR AN APPLICATION INVOLVING SERIOUS RISK TO LIFE OR PROPERTY WITHOUT ENSURING THAT THE SYSTEM AS A WHOLE HAS BEEN DESIGNED TO ADDRESS THE RISKS, AND THAT THE OMRON PRODUCT IS PROPERLY RATED AND INSTALLED FOR THE INTENDED USE WITHIN THE OVERALL EQUIPMENT OR SYSTEM.

Disclaimers

CHANGE IN SPECIFICATIONS

Product specifications and accessories may be changed at any time based on improvements and other reasons.

It is our practice to change model numbers when published ratings or features are changed, or when significant construction changes are made. However, some specifications of the product may be changed without any notice. When in doubt, special model numbers may be assigned to fix or establish key specifications for your application on your request. Please consult with your OMRON representative at any time to confirm actual specifications of purchased product.

DIMENSIONS AND WEIGHTS

Dimensions and weights are nominal and are not to be used for manufacturing purposes, even when tolerances are shown.

ERRORS AND OMISSIONS

The information in this catalog has been carefully checked and is believed to be accurate; however, no responsibility is assumed for clerical, typographical, or proofreading errors, or omissions.

PERFORMANCE DATA

Performance data given in this catalog is provided as a guide for the user in determining suitability and does not constitute a warranty. It may represent the result of OMRON's test conditions, and the users must correlate it to actual application requirements. Actual performance is subject to the OMRON Warranty and Limitations of Liability.

PROGRAMMABLE PRODUCTS

OMRON shall not be responsible for the user's programming of a programmable product, or any consequence thereof.

COPYRIGHT AND COPY PERMISSION

This catalog shall not be copied for sales or promotions without permission.

This catalog is protected by copyright and is intended solely for use in conjunction with the product. Please notify us before copying or reproducing this catalog in any manner, for any other purpose. If copying or transmitting this catalog to another, please copy or transmit it in its entirety.